

Basic Armouring

A practical Introduction to Armour Making

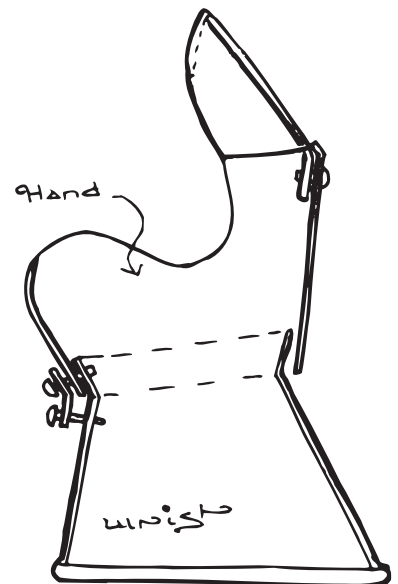

Paul Blackwell ❖ Second Edition

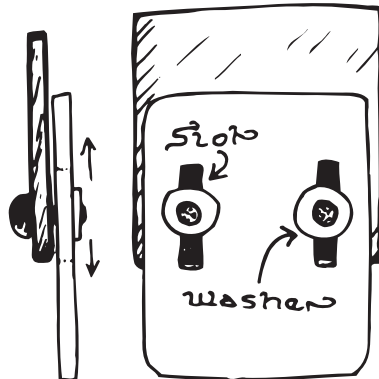
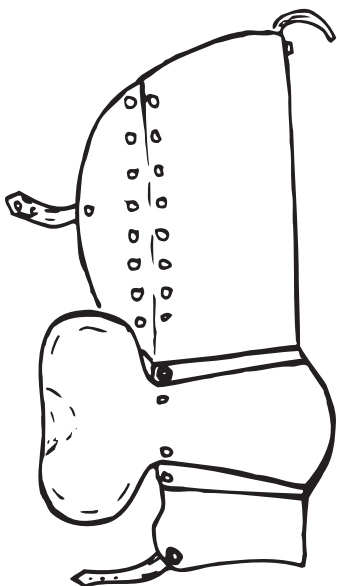
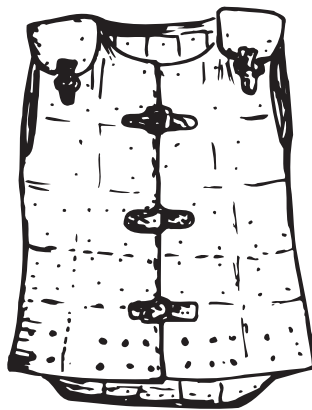
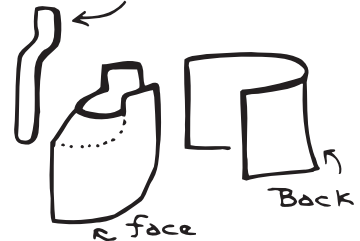
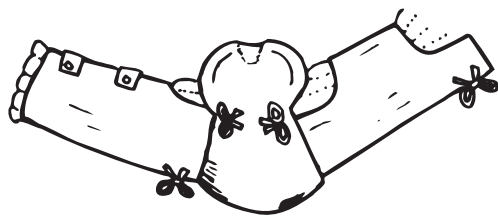
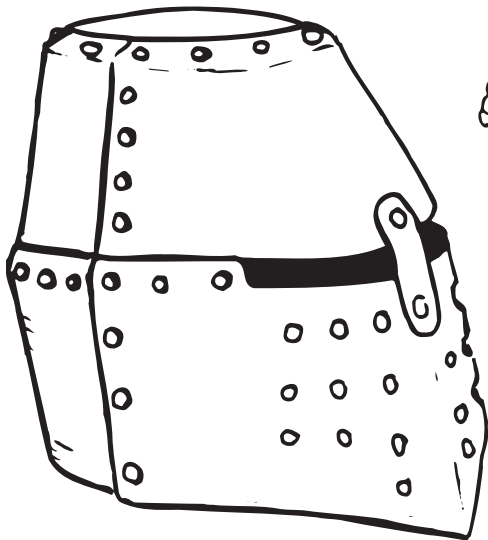
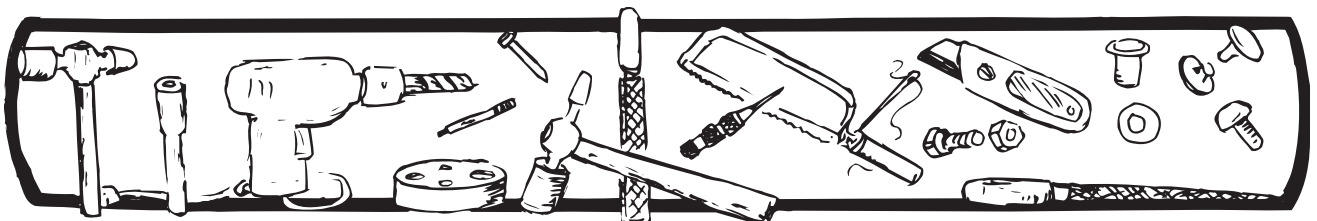

Basic Armouring

A practical Introduction to Armour Making



Paul Blackwell ✦ Second Edition

Basic Armouring—A Practical Introduction to Armour Making, Second Edition
By Paul Blackwell

Publishing History

March 1986: First Edition

March 2002: Second Edition

Copyright © 2002 Paul Blackwell.

This document may be copied and printed for personal use. It may not be distributed for profit in whole or part, or modified in any way. Electronic copies may be made for personal use. Electronic copies may not be published.

The right of Paul Blackwell to be identified as the Author and Illustrator of this work has been asserted in accordance with the Copyright, Designs and Patents Act 1988.

The latest electronic version of this book may be obtained from:
<http://www.brighthelm.org/>

Ye Small Print—Cautionary Note and Disclaimer

Combat re-enactment in any form carries an element of risk (hey they used to do this for real!) Even making armour can be hazardous, if you drop a hammer on your foot, cut yourself on a sharp piece of metal or do something even more disastrous! It must be pointed out, therefore, that if you partake in silly hobbies such as these you do so at your own risk!

The advice and information in this booklet is given in good faith (most having been tried out by the author) however as I have no control over what you do, or how you do it, I can accept no liability for injury suffered by yourself or others while making or using armour.

Ye Nice Note

Having said all that I'll just add that I've been playing for ages and am still in one piece and having fun.

Cheers, Paul

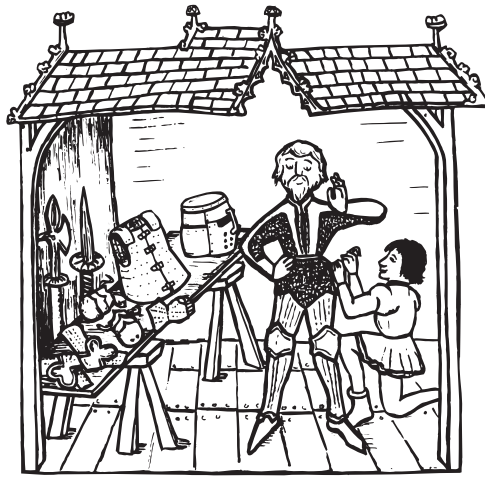



Table of Contents

Introduction	1
Materials	3
Tools.....	7
Saftey	13
Leather Working Techniques	15
Metal Working Techniques.....	17
More Advanced Metal Working Techniques	19
Padding.....	23
Head	29
Neck.....	41
Body	45
Arms	53
Hands.....	65
Legs.....	77
Shields.....	87
Maintaining Armour	93
Authenticity	95
Fighting Styles	97
Aftermath	101
More Bits.....	103

TABLE OF CONTENTS



Chapter 1 — Introduction

Stepping out into the world of medieval combat recreation can, like any other sport, be somewhat daunting. To start with where do you get all the equipment you need, especially all that nice shiny armour? Well here are your options:

1. Borrow it (a good way to start if spare stuff is available)
2. Buy it new (can be expensive)
3. Buy it second hand (cheaper but will it fit or be worn out already?)
4. Make it yourself.
5. Any combination of the above!

This booklet is a primer for those who want to try the fourth option; it sets out to show you how to make simple, but practical, armour. Beware though, armour making can become a hobby in its own right and this book is but an introduction! In time you may want to make even fancier, more complex and more authentic armour, in the meanwhile this book should get you out on the field! Enjoy.

Before you begin armouring

Decide what you need! This may seem obvious but experience has shown that people can rush out, make something entirely inappropriate, then wonder why no one will let them play in it! Sad but true. To avoid this first check out what the local armour requirements are — read the rules, ask a marshal or another fighter, people like to help (more fighters equals more fun). A lot can be learnt by simply talking to experienced fighters. “Oh you don’t want one of those — they weigh a ton — stops you running about! Want to buy my old one?” Try and decide on a style that will suit both the way you want to look and the way you want to fight then start

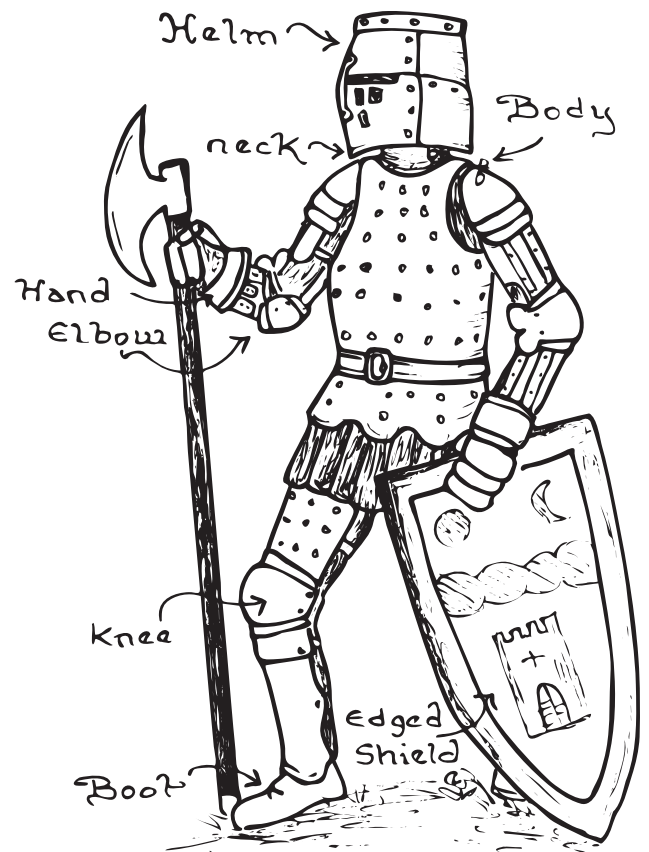

thinking about how to achieve it. The sketch to the right shows what is generally required. (For more information see Chapters 18 and 20.)

Fitting

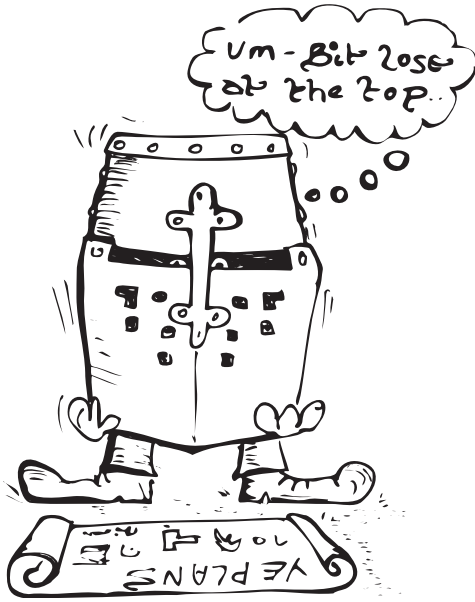

Obviously your armour should fit you. This means patterns etc. will need adjusting. Therefore don't just go out and copy an existing piece and expect it to fit — it probably won't. If you have been borrowing armour you will probably have noticed this effect already; universal fit means that it universally doesn't quite fit anybody. What is not so obvious is that your armour should fit you and what ever else you are wearing. Padding can change your size and shape considerably so build your armour around it, not the tee shirt you wear in the workshop. Armour should also allow you to move; if it catches, rubs painfully or jams then you've done something wrong — fix it.



Chapter 2 — Materials

World wide period armours were made out of just about anything; cloth, metal, leather, bone, horn, bamboo; basically if it was available and it worked it was used! European armours tend to be less esoteric and generally stick to metal and leather over cloth. When looking for materials shop around, look for off cuts, remnants, or consider buying in bulk. Armour doesn't have to cost a fortune.

Steel

Sheet steel is easily obtainable these days; look in the Yellow Pages under *Metal Stockists*. In the 1800s Sir Henry Bessemer invented a new process for making steel. Modern steel is therefore very different to period stuff; in fact it's a lot better! *Mild Steel* is the easiest and cheapest to get hold of and the most convenient to work. For one thing you can easily cold work it - which means you don't need a forge. Mild steel contains less than 0.25% carbon, has a non-fibrous structure and will take a high polish - it does rust however. It comes as either bright rolled sheets which are shiny and hence easiest to polish or hot rolled, which are marginally easier to work and come in a black colour. *Galvanised steel* is mild steel with a coating on it to stop it rusting which is fine until you scratch it; it is a nasty grey colour and isn't suitable for anything that involves a lot of shape changing. I tend to avoid the stuff! *Stainless steel* comes to a variety of specifications; it's more expensive than mild and more difficult to work, however, if you get the right stuff it won't rust. If you plan to do anything dramatic to stainless you will need to *anneal* it, which will require heat, more of which later.

Mild steel is the best stuff to start off with. It is sold in sheets (generally 2 x 3 meters) of various thicknesses. To be confusing these are often referred to as *gauges* — of course there are different gauge systems from around the world and

Mild Steel for Armour			
Thickness (mm)	Gauge (UK)	Used For	Notes
1.0	20	Edging shields, body plates	Light weight, dents easily
1.2	18	Arms, legs	Will dent, but isn't too heavy
1.5–1.6	16	Elbows, knees, helms	Nice for dishing, can be used for arms and legs
2.0	14	Helms	Starting to get heavy!

MATERIALS

the British gauge system changed when we went metric! Best way round this is to tell the stockist what thickness you want and let him sort out the rest! The table below gives you an idea of what is suitable; the 1.5 to 1.6 mm for 16 gauge is because the old imperial stuff was 1.6mm and the new metric is 1.5. You can still get stuff rolled to the old size if you are lucky! Toughness wise stainless is roughly equivalent to the next gauge up of mild steel.

Leather

Leather is a wonderful material for making armour out of. It can be shaped, left soft to act as a pad, made hard so as to be armour in its own right or just cut into straps to hold everything together! Leather can be purchased from leather factors, warehouses, re-enactors markets (good cheap supplies) or through craft outlets. As with everything else shop around.

Leather for Armour	
Type	Explanation and Use
Rawhide	Untanned, makes good shield edging (dog chews are a good source). Soak in water to make pliable then allow it to dry to make it hard again.
Vegetable tanned	'Period style' leather tanned using natural tannin from tree bark. Straps, coats of plates etc. Can be dyed. Good idea to give it a waterproofing finish (wax, oil).
Chrome tanned	Modern curing process using chromium salts. Straps, coats of plates etc. Comes in a variety of colours.
Suede and Split	No smooth face - not very strong - avoid!
Tooling leather	Vegetable tanned leather without waterproofing finish. When wetted becomes soft and pliable. Can be moulded to shape when wet.
Sole leather	Thick leather; often compressed for extra rigidity. Good for plates etc. Expensive







Rivets

The vast majority of your armour is going to be held together by rivets. Look in Yellow Pages under fasteners. Ironmongers, DIY centres, craft shops and leather fittings retailers may also sell certain types. Rivets come very cheap if you buy in bulk (50 plus) rather than in little packers of 10 or so.

Mild steel rivets come in a variety of sizes and lengths — I've ended up with a huge variety! I mainly use 3/16 inch diameter, that's 4.8 mm for you metric types. Length wise I keep lots of 1/4 inch for riveting two pieces of metal together and 3/8 inch for riveting three bits, articulations and the like. It's also worth keeping a few really long ones, you can cut down, for that annoying job where the ones you have don't quite reach. The only other diameter I use a significant number of is 1/8 inch (2.4 mm), for fingers on gauntlets and other fine work.

Tubular rivets with a head size of around 1/2 inch (13 mm) are useful. There is a special tool for setting these things — I find that putting them onto something flat and hitting them with a hammer works fine! The double headed type shown above are superior to the thin back type as they last longer and you can put them in upside down without going, "Darn, that looks wrong!"

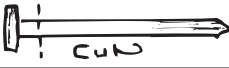
MATERIALS

Rivets for Armour			
Type	Material	Use	Looks Like
Flat Head	Mild Steel	Helms ('cos they wreck rattan swords less!)	
Round Head	Mild Steel	Articulations ('cos they look nice!)	
Flat/Round	Brass	Decoration	
Tubular	Aluminium, often coated to give Brass effect)	Riveting onto leather or cloth. Not authentic but great for straps, buckels, etc.	
Nails	Mild Steel	Can't find a rivet? Cut a nail down!	
Roofing Nails	Mild Steel	Riviting onto leather or cloth —very cheap!	

Wood

Plywood makes good shields — obtainable from any DIY shop, builders merchant or the like.

Brass

Expensive, heavy and not strong enough for important pieces; brass is however great for decoration.

Aluminium

Not at all period. However sometimes turns up as scrap and can be used to make lightweight body plates or the like. Dural, aircraft grade aluminium alloy, is much tougher and can be used to make shields.

Thermoplastic

Not period, surprise! Ideal for lightweight body plates or hidden stiffeners under leather or cloth; sort of inauthentic hard leather. Great for keeping your total armour weight down so as to avoid excess baggage charges when flying to events around Europe. Can shatter if it gets too cold, for exaple, Finland in winter. Guess how I found that out?

Cloth

Used to make undergarments or to hold armour together as in coat of plates and the like. Markets, material remnant shops, re-enactors markets, charity shops, sewing shops and the like are good places to look for materials at reasonable prices. If you are looking for canvas you can also try a tent maker or camping shop.

MATERIALS



Chapter 3 — Tools

You are going to have to acquire a few basic tools, as you progress you will probably acquire a few more! New tools can be expensive so start looking around second hand tool shops, junk shops, steam rallies, agricultural or engineering auctions or tool sales. You will also need a place to work, somewhere where the noise won't drive the neighbours mad. You are also going to need somewhere with a good floor or you will hammer through it! A shed or garage is fine.

Hammers

You will need a hammer to rivet with; a small ballpein, about a pound weight, is ideal. You will also need a soft hammer to bend things with, look for a relatively hefty rubber or rawhide mallet. These you should be able to find easily. It's also useful to have a thumping stick for bashing things like nails or cold chisels; basically a fairly heavy hammer whose face you don't mind chewing up!

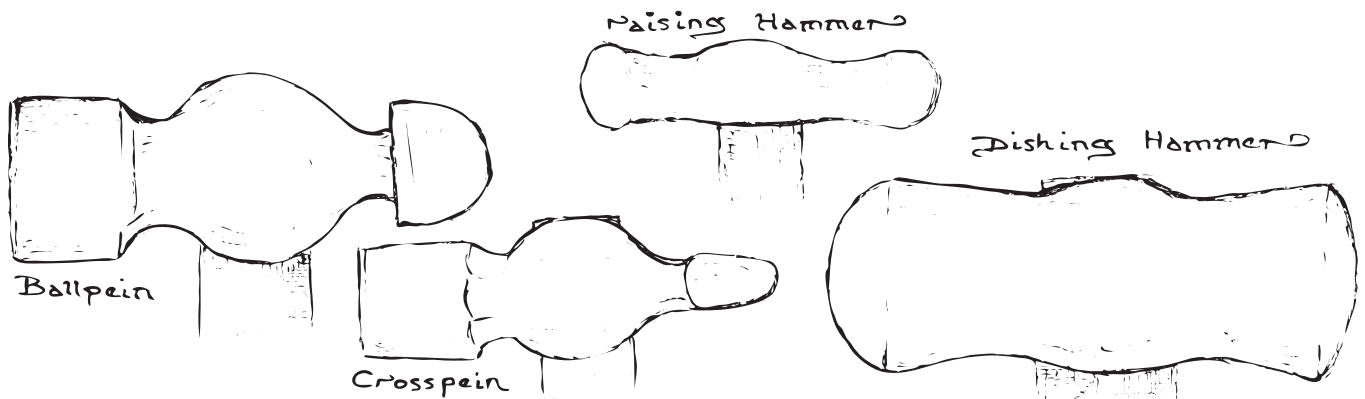

For shaping work you will need hammers with polished faces. Any marks you put into them will be transferred to your work so keep them separate from the general use hammers. A dishing hammer (for making elbows, knees etc.) is a must; anything relatively hefty with a curved face will do. A large round end ballpein can be used, although the curve will be a bit extreme, or you could always grind a flat faced hammer down a bit. It is probably better though to look for a purpose made dishing hammer. Purchasing one new is a good investment although finding one second-hand shouldn't be too much of a problem. Collecting a variety of dishing hammers will be very useful. A planishing hammer is used to

TOOLS

smooth surfaces and remove hammer marks; any flat-faced hammer will do. If you need to do any raising you will need a hammer for this; a large purpose raising hammer is best but the back of a cross pein can be used.

Formers

You will now need something to hammer onto. No don't rush out and buy an anvil — they can be helpful but are hardly essential, unless you want to be a blacksmith as well. Instead find yourself a tree stump. If you cut a slight hollow into one part of the top this will form a *dishing block*. The rest can be used for hammering onto. Also look for pieces of hardwood as these can be cut into very useful shapes for forming things around. Other things to keep your eyes open for are lengths of metal tube (for bending things over or around), bowling balls and odd chunks of metal. Be inventive, failing that buy some stakes — these come in a variety of shapes and sizes, the mushroom shaped being probably the most useful. Unless you are rich buy them second hand.

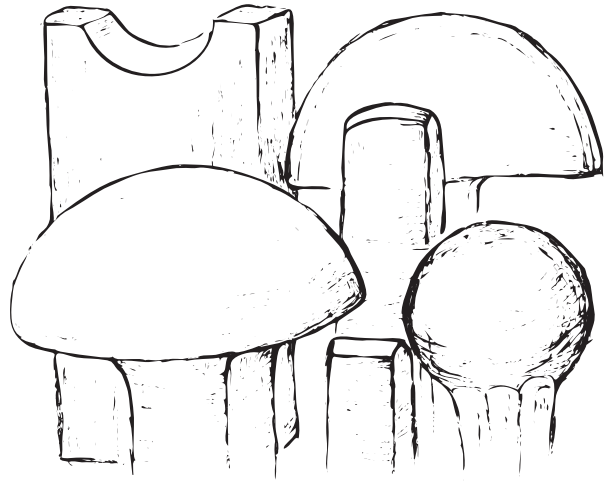

Riveting Block

You will need a smooth, flat, hard, surface to rivet onto. If you want to use round head rivets you will need a rivet snap of the correct size. I use an old lump of stainless steel with curved holes drilled into it.

Workbench

Something for marking things out on, holding a vice or clamps, bashing things on etc. Get something the right height. (Workmates tend to be very low.) I made mine out of an old bed frame and scrap wood.

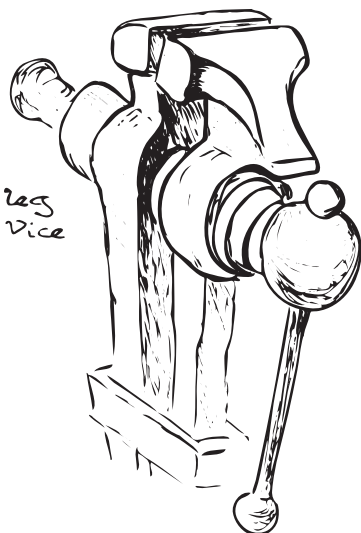

Vice

For holding things like formers, what you're filing, what you want to thump and a hundred other jobs. The easiest to get is an engineers vice; unfortunately these don't like being thumped! Instead try to get a leg vice, some times called a blacksmiths vice, they are fairly common second hand and are designed to be hammered onto. Mount it onto your workbench.

Cutters

Making armour will involve cutting lots of devious shapes from pieces of metal; a decent cutter is therefore a good invest-

TOOLS

ment. A decent cutter is perhaps the most awkward tool to find at a reasonable price.

The cheapest tool I've ever seen used was a cold chisel. Simply chisel the shapes out on an anvil, then grind them into something useable. Very noisy and time consuming — not recommended.

At the bottom end of the more practical range of tools is the humble hack saw — cheap, cheerful but will take you forever. You can use an electric jigsaw but they tend to be very noisy and rather time consuming as well. Make sure you use the correct blade and support the steel to prevent it bouncing around.

Snips, sometimes sold as Tinsnips or Shears will cut thin steel but you will need a gigantic pair to cut 1.2mm or above with any ease. This is actually very period. Compound action snips or Aviation snips give you a mechanical advantage when cutting; they only handle up to 1.2mm steel though.

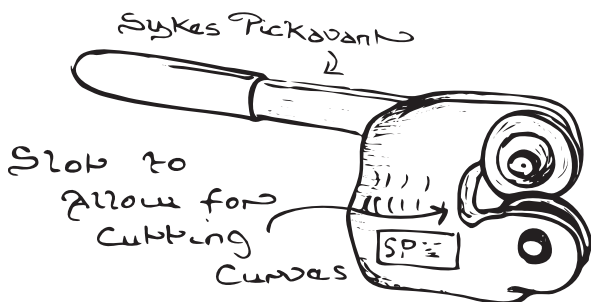
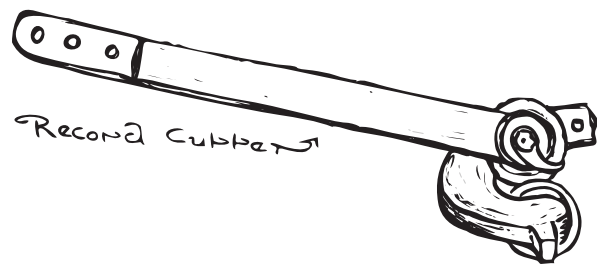

Once upon a time just about every engineering shop in Britain had a pair of Record wheel cutters — then someone invented power tools. You can still occasionally find them second hand, though as one dealer said “They are as common as rocking horse shit.” They operate like a giant can opener and can cut lines, curves or complex shapes into 1.6mm or thinner steel. They are supposed to mount into a special block, though I've never seen one, but a vice works fine. They also come with an extra handle so you can use them hand held; great for cutting sheets in half. If you see a pair buy them! A similar machine is a Sykes Pickavant Mini Cutter which can also handle up to 16 gauge mild steel.

Modern workshops use floor or bench mounting shears, power nibblers or power shears — yep they all sound expensive. The bench-mounted shears are giant guillotines, which cut straight lines very well; they aren't so hot on curves. Nibblers work by punching lots of small lumps out of your sheet, rather messy and very noisy. Power shears are great if you afford them (around £300) and aren't left handed like me. Depending on the input power they can handle thick plates (for example, a Bosch GSC2.8 will cut up to 2.8mm steel). I have seen a nibbler attachment for an electric drill

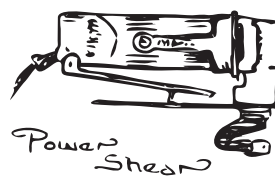

Nice if you can afford one

Nice if you can import one

Nice if you can find one!

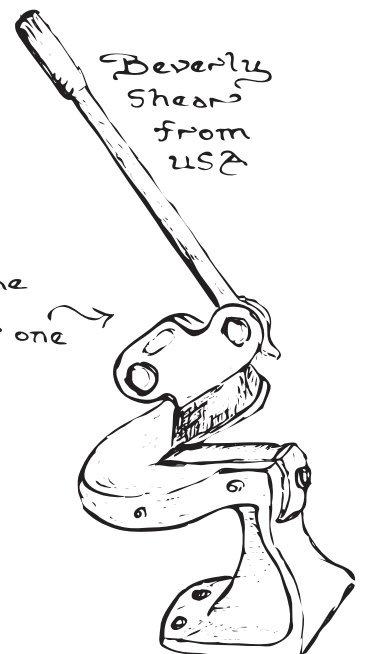
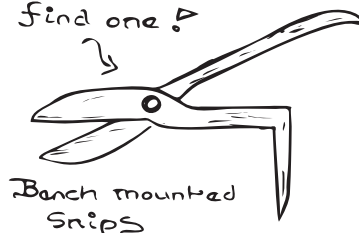

made by Falcon Tools that claims to cut up to 1.5mm steel but have never tried one. Good hunting!

Hole Maker

To put rivets in you need holes. For cloth push a sharp point through, thus cutting as few fibres as possible. For leather get a punch — belt punches are far superior to the hand punches, with the rotating head, which tend to bend if used a lot. For metal a good old electric drill does fine; use HSS drills not wood working ones, or if you want to drill stainless use Boron Carbide tipped drills. If you put a leather washer on the drill next to the chuck you will prevent it scratching if you push your drill in too far. Period armourers probably punched their holes, the modern equivalent is to use a hand punch such as a ‘Whitney metal punch’. I invested in one of their “No.5 junior hand punch” sets a few years ago and found it saved a lot of time and effort! It punches 3/32 to 9/23 inch holes in up to 16 gauge steel. You will also need a centre punch to mark where your holes will go (and give a drill tip something to start off on). After years of cursing the automatic spring loaded punches I gave up and went over to using a good old solid punch and a hammer. So much for modern technology.

Files

A hand file will remove rough edges, finish or shaping your piece or remove that awkward little bit that is jamming things — a small round file will correct that hole that isn’t quite in the right place. Files come in a variety of shapes and degrees of coarseness — it’s worth having a selection. Keep them clean with a file brush (to stop the teeth clogging) and always use them with a handle.

Polishing

A simple polishing and fine grinding machine can be made by mounting a foam sanding wheel on the front of an electric drill. If you mount the drill in a stand things work even better! 150 grit fine belts will remove sharp edges and do fine shaping; when they get worn they can be used to polish. DIY shops only sell 150 or less grit. The less the number the coarser the paper. Tool shops sell finer grades normally for belt sanders but they fit wheels, just check the diameter when you buy. I find 220 or 280 grit give a nice finish.

A fine polishing machine can be made from a cheap bench grinder. Take the grinding wheels off and replace them with mops. OK they don’t run up to the same speed as a proper polishing machine but they cost a tenth of the price and don’t need a three phase electric supply! If you put a Sisal mop on one side, a stitched cloth finishing mop on the other and use stainless steel polishing compound you can get a mirror finish with a bit of effort.

Other useful bits

Fine felt tip pen for marking things out, scissors, cardboard and sticky tape for templates, nuts and bolts to hold bits together before you rivet them, cold chisel

TOOLS

for getting things apart when you rivet them in the wrong place, G-clamp to give you that extra hand (evolving without a tail was definitely a mistake), washers, trimming knife for cutting leather, pliers, even more hammers.

TOOLS



Chapter 4 — Safety

If you are going to do something do it well and do it safely. Wear leather gloves whenever possible to stop you getting cuts; hey they even make ones with Kevlar in these days. Throw away sharp edged off cuts, swarf, etc. somewhere safe; not the floor or the bench you are about to put your hand. Remove sharp edges before holding bits with your hands and before wearing it! Wear eye protection especially when drilling, grinding, sanding or polishing. Wear a dust mask when polishing, sanding, grinding, etc. When drilling make sure the item is held firmly and remove any swarf caused by the drilling. Ear protectors are a good idea especially when dishing or using a noisy cutter. Wear toe protection footwear and wear sensible clothing.

Armouring is fun; injuring yourself isn't! DIY shops and industrial clothing/safety shops will sell protective bits — they are a good inexpensive investment, *Honest!*

SAFETY



Chapter 5 — Leather Working Techniques

Lots of books have been written on sewing, leather and metal work so it doesn't really make sense to repeat all that information here! Pop down to the library and have a browse - the bits in the next few sections are really just notes to get you started. For a useful book list see Chapter 20.

Shaping

Leather is a flexible material and can generally just be bent to shape. Hard leather such as sole leather needs to be made flexible by wetting it. When wet tooling leather can, surprise-surprise, be tooled (pressed down on to give interesting patterns). When making straps and the like remember that leather stretches — add a few extra holes!

Cuir Bouilli

If you soak vegetable (natural) tan leather, stretch it around a former, wood is good, then dry it slowly in a low oven it goes rock hard. Polish it on the outside to keep water out and you have a nice piece of armour.

LEATHER WORKING TECHNIQUES



Chapter 6 — Metal Working Techniques

Riveting

There are two purposes to riveting. The first is to hold things firmly together, as on a helmet, the other is to form a pivot, as in an articulated knee.

For a firm fit drill a hole in both pieces the same diameter as your rivet then pein the rivet fully down to the inner plate.

For an articulation make the hole one size bigger than the rivet and pein the head over lightly. A washer on the inside is helpful. A leather washer between the two plates surfaces has several purposes, it holds the two moving surfaces apart giving them room to move, stops the rivet falling out (if its a tight fit on the shank) when you turn everything over for peining and allows you to keep the rivet loose without rattling.

Peining simply involves hammering the end of the rivet to form a second head — bring on the ball pein hammer! Place the rivet through the holes in your pieces with the head on the outside. Place the head down onto a hard flat surface, into a rivet snap or into a cut out that matches its head. Now using the ball end of the hammer hit the top of the exposed shank to mushroom it. Smooth out the pein using the flat face of the hammer. Remember this is the inside of your armour — you want something smooth and relatively flat pointing at your skin don't you?

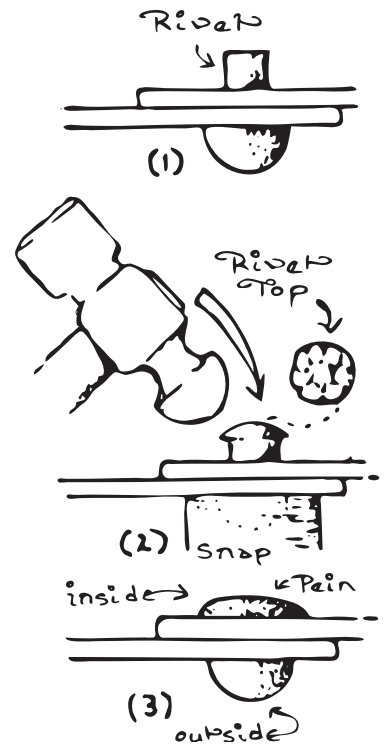

Bending

It's very easy to push a bit a metal and bend it at that point; what is trickier is to get a curve over the *entire* length. Long bends are best achieved by hammering down over a former; a bit of metal tube, a log, pipe, stake, whatever — provided it's curved. Start by curving the entire length. Don't worry unduly about how much just get the metal moving. Now hammer it some more, push it with your hand, and hammer it back if you have gone too far, until you reach the desired shape. Use a *soft* mallet to avoid marking the metal.

Dishing

Think of a piece of clay; if you push your thumb into it a number of times you can squeeze it out into a bowl shape. If you push it into a bowl shaped former it is even easier to form it. This is in essence what you are going to do with your piece of steel using a hammer and a dishing block.

There are two theories of dishing depending on whether you are a Tinsmith or a Silversmith. One says work from the outside in, the other says work from the middle out; I find it makes no difference.

To dish a piece first mark some guide lines; when you start you may want to draw lots of concentric lines, when you get more experienced you may just want to mark the centre. Place the piece over your dishing hole and start hammering around your guidelines. Holding the piece in a glove cuts down the vibrations to your hand, ear defenders cut down the noise to your ears. What ever you do *don't put your hand between the block and the bit you are about to hit*. I've seen it done — ouch! Work evenly around the shape. On each pass (time round the entire piece) try to even out the hammer marks from the previous pass. If the piece starts to bend dramatically, in a fashion you don't want, straighten it out either by putting it in the vice and pulling or by hitting it over a stake with a flat-faced hammer. If the edges start to crinkle, flatten them out immediately over a former with a flat-faced hammer (otherwise the metal may crack). If your surface is uneven either finish it off by doing a final pass on a flat surface or by planishing (see later). A selection of hammers, with different curves to their faces makes life easier. Dishing can be done onto a flat metal surface, such as the face of an anvil. This is very noisy!

Polishing

Even bright mild steel comes with a protective coating, to stop it instantly rusting, which has to be removed to achieve that bright polished look. You can either polish by hand or by machine. Start with the coarsest grade working in one direction. Continue with a finer grade working across the direction of the last grade, so you can see when all the marks have gone. Keep going with progressively finer grades of grit then polishing compound until you reach the finish you need. Doing a bit of initial polishing on things while they are still flat will save a lot of time! Keep things shiny with coatings of car body polish or wax (neutral shoe polish) and avoid rain. Ha! Fat chance!



Chapter 7 — Advanced Metal Working Techniques

Annealing

This is heating metal to stress relieve it. If you hammer repeatedly on a piece of metal it will work harden and become less pliable and more brittle. Mild steel is remarkably resistant to this — stainless steel isn't! For steel, to relieve the stressing, heat the offending piece to red heat using a forge, or blowtorch then allow it to cool slowly. Note that brass and other materials work differently — look them up before you start.

Raising

Think of the piece of clay again, this time fold it down over your thumb squeezing the folds flat as you go. Raising can be considered the superior forming technique because, unlike dishing, it does not thin the piece out as you go. It also requires the most work; lots of hammering leads to work hardening, even on a relatively small piece, so annealing may well be required. You dish on the inside and raise on the outside of the piece. Most period pieces were probably raised; most modern pieces are probably dished.

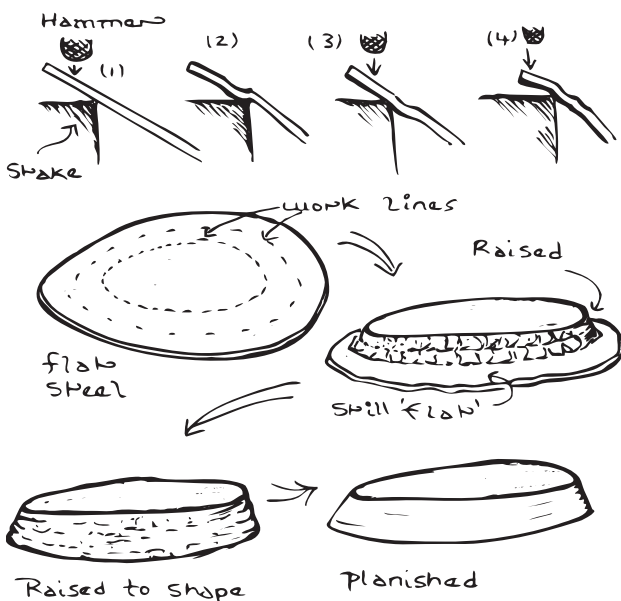
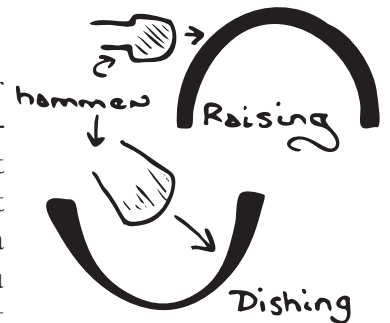

For raising you will need a *stake* that is a bit of bar stock or the like you can hold in the vice to fold your metal down onto. Before you start, mark the area to be raised; as with dishing the number of lines you use will depend on your experience with the technique. There are several ways of working all of which use the same premise — place the piece at an angle against the stake, strike the portion projecting above the stake to drive it down. You can start at the top or bottom of the area to be raised. You can also start by *crimping* the edge (bit like a bottle cap) by hammering it into a V shaped former, in which case you start raising from the inner

edge. Work in circles driving the metal evenly down. After each complete pass anneal the metal and start again driving it further down. Finish by planishing.

Edge Rolling & Wire edging

One of the primary ways of strengthening pieces and persuading them to stay in shape while others clout them with swords, axes and the like. There are two ways of rolling, with the roll on the outside or inside, and wire edging is just a roll with something solid in the middle; which you use depends on personal choice and what period you are trying to reproduce. All three methods start off the same way fold/raise a lip onto the top of the piece; about 1cm is good but it will vary depending on wire thickness, effect you want. The important thing is that it is even and flat especially at the ends, which fold easily, and around curves in the middle, which require more raising. As always work in stages and work evenly. Next bend the lip over in a curve; if you are wire edging, trap the wire under the lip as you bring it down. Again the trick is to work in stages and work evenly. If you push a section down

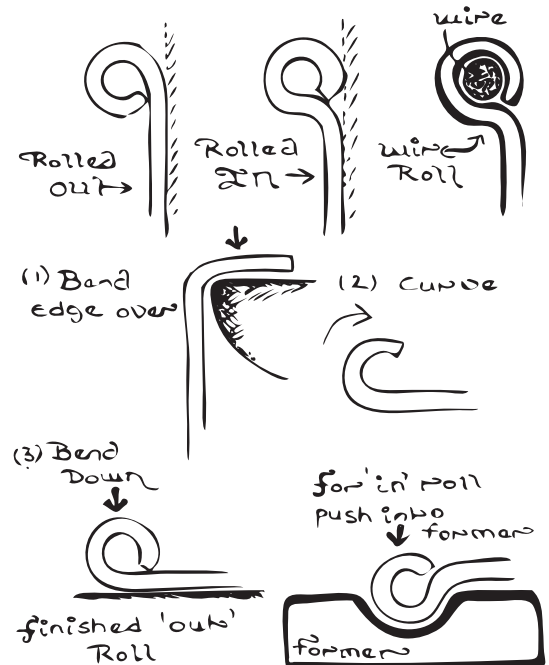

on its own it's liable to crease and ruin the effect. For a roll on the outside that's it. For a roll on the inside you have to push the roll back. To do this finish your roll on a former with a notch cut in it the same size as your roll.

Planishing

Or how to polish with a hammer. Planishing gives you a nice even surface without grinding or the like. Useful for getting surfaces flat, blending hammer marks in or getting rid of the odd mistake. Simply place your piece, outside facing up, over a former of the same shape and hit it with a flat polished hammer. Do this to the entire surface, working evenly, to achieve the desired effect. Think lots of little strikes not one huge one. What you hit onto only has to match the shape where you hit it so a bar with its top ground can be used for a large piece. Dome stakes have various curves on them so you can move you piece about to get a match.

Welding

You want one of those nice open faced helms with a barred grill or a fancy basket hilt? Then you are going to need to weld it. Welders aren't cheap but can be hired, along with the necessary eye shield, from tool hire shops. Some people cut-and-weld to achieve complex forms—period armourers used a hammer which, incidentally, also works well for the starting armourer. Period craftsmen also used to forge weld but we are definitely not going to get into that. Even modern arc welding is not really in the remit of *Basic Armouring* so consult your library or

local tech college course to learn more. Failing that ask a friend with a welder to do it for you; Hey, who said you had to do all the work?

Articulations

You will need articulations to make all those nice shoulders, gauntlets, elbows and knees with the neatly fitting lames. However many starting armourers shy away from them as being, “horribly complicated!” This is largely due to a misconception of what an articulation is; consider “Articulate, (a) Having joints; connect by, divide with, joints.” So anything holding two plates apart and allowing them to move can be considered an articulation. Riveting a piece of leather between two plates articulates them—and you can’t get much simpler than that can you? Well actually you can! Lacing the pieces of your arm armour onto your gambeson controls the distance between them and their relative movements—who said this was complicated?

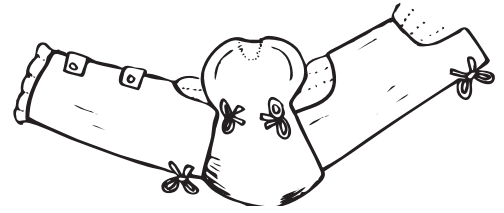

Leather Straps

Leather straps provide movement on a wide variety of period armours. Consider the following when using them:

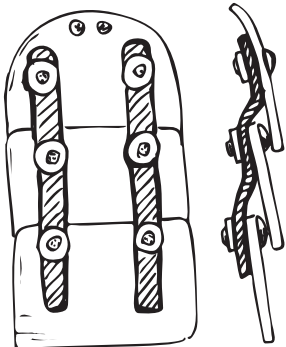

1. Rivets pull through leather—use a washer next to the leather to spread the load.
2. Don’t make your straps too narrow or they will break!
3. Don’t make your straps out of very thin leather or they will break!
4. One long strap is easier than lots of little ones!
5. The plates will need room to move; if the edge of the plate is millimetres away from the rivet in the next plate it will only be able to move millimetres!

Sliding rivets

These provide a ‘side to side’ or ‘up and down’ type of movement. To produce a sliding rivet simply file one rivet hole (generally the inside one) into a slot then loosely rivet the plates in place; you generally need a sliding joint on both sides to get the plates to move. Useful hints:

1. The slot goes in the direction of movement - it can be a curve if necessary.
2. For ‘side to side’ movement the slots need to be close to the front of the inner plate or everything will lock up and jam.

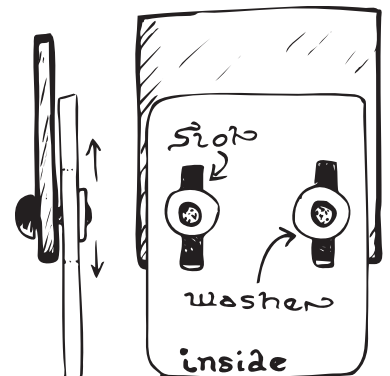

Rotating joints

These are particularly useful on elbows and knees. The trick is to get the plates to articulate smoothly to a certain point then lock against each other and stop. If they don't lock they will keep moving and gap; gaps allow weapons to get in. Gaps are bad!

The diagram to the right shows how the lames work; the upper lame is shown rotated fully out, the lower one rotated fully in. Note how the curvature of the lame matches that of the cop when it is in the fully out position.

Everything depends on where you place the rivet holes:

1. Rivet holes are symmetrical; if the hole on the right side of the lame is 1cm in the hole on the left should be 1cm in.
2. Note how, with the lower plate fully in, the line of rivet holes are on a curve not a straight line.
3. In the fully in position the lame project below the surface of the cop, therefore you need to allow room for it between you and the cop, that is the cop isn't a skintight fit to the joint.
4. Remember to make the rivet holes one size larger than the rivet or else the rivet shank will compress, as you pein it, locking everything in place!

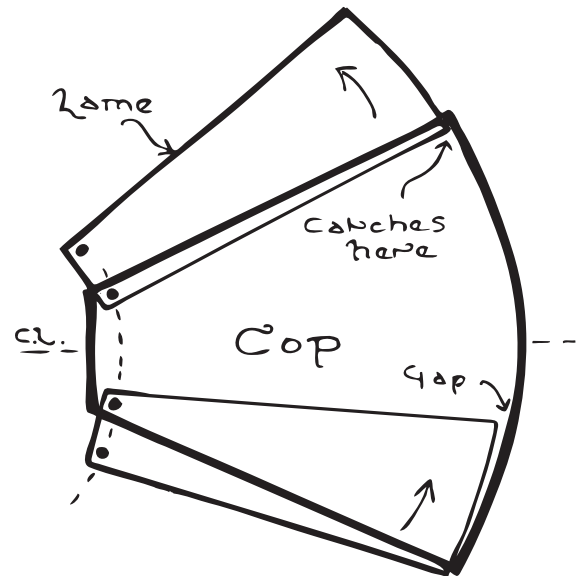



Chapter 8 — Padding

Because you need to build your armour around your padding you need to know how to make it first!

Gamberson

This supplies basic padding under the body armour and something to hang your arm armour off. Some people rely on their gamberson (with a few minor additions such as a kidney belt) as their torso protection. This gives them excellent mobility at the expense of protection. If you are learning to fight, as well as armour, you are liable to get hit a lot so body armour might not be a bad idea—your choice!

Making a gamberson is a sewing job; go get a needle and thread or borrow a sewing machine. The material you make it from should be relatively tough (it's going to take a beating), adsorbent (you are going to sweat into it), colour fast (unless you want to start a new fashion in oddly coloured flesh) and washable (see sweating above). Period gambersons were made from multiple layers of cloth stitched together or padded with raw wool or similar material, modern ones often use an internal fill of cotton or polyester batting to achieve the same look with less weight. A description of an arming doublet of the 15th century is “a dowbelet of ffustean (a type of heavy woollen broad cloth) lyned with satene cutte full of hoolis”. A heavy outer material, such as canvas or calico, is therefore appropriate with a softer lining next to the skin. For extra ventilation you can add buttonholes down the quilting seams.



A Dark Ages → 12th Century
Basic short sleeved Gamberson

The shape of your gamberson (see illustrations above) depends on the period you are trying to portray. From a practical point of view it should allow you to

PADDING

move. Arm movement is especially important; if you can't cross your arms in front of you or move your arm above your head the design is too constricting.

A pattern that will work well for most gambersons is as follows:

- Take measurements as shown to the left.
 - A= 1/2 upper chest (arm to arm)
 - A'= 1/2 upper back (armpit to armpit)
 - B= 1/4 chest measurement
 - C= 1/4 waist measurement
 - D= 1/4 hips measurement plus 2 to 5 cm
 - E= collarbone to waistline
 - F= waistline to bottom of skirt
 - G= back of neck to waistline
 - H= waistline to bottom of skirt (back)

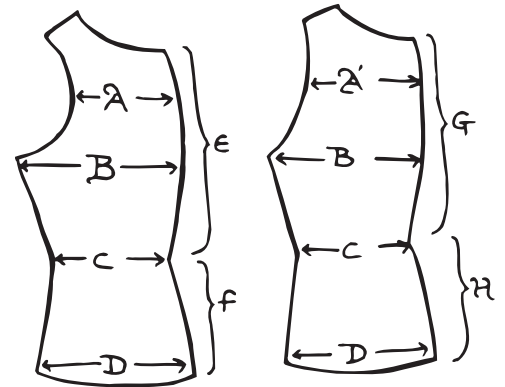

Note that the waistline in the late medieval period tended to be higher than today's and was measured just under the ribs. This will give you the basic torso.

For earlier period gambersons the measurement C should be about the same as measurement D giving a tubular trunk. Later period tended to have a more pronounced waistline following the whims of fashion, in which case measurement C should be a rather snug fit.

For a flared skirt increase measurement D. Remember to keep the armholes large for ease of movement.

- Cut out one set of panels, baste together (long, easily removable stitches) and try it on. Go through your range of fighting motions and make sure that it does not pinch or bind. Cut and modify to suit then remove the stitches,

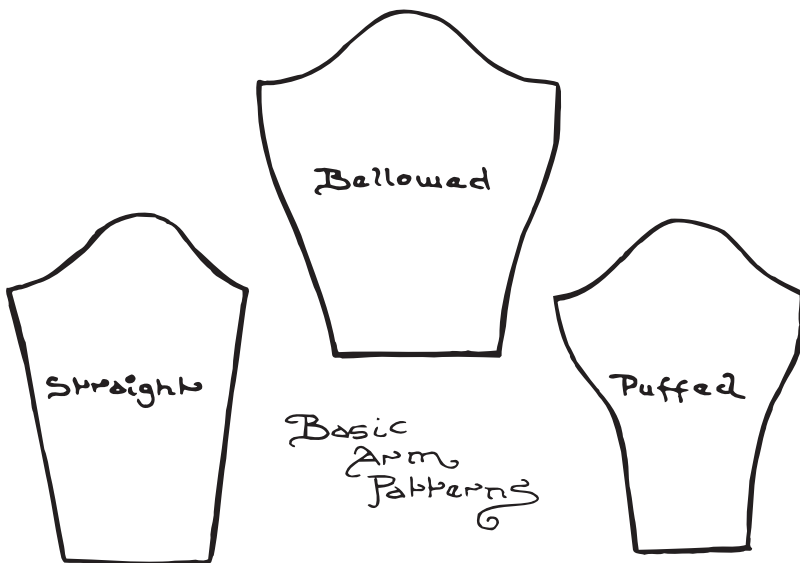

add 5 to 8cm extra (2-3 inches) to the measurements to allow for the quilting then use the adjusted pieces as patterns to cut the rest of the cloth.

- You can make gambersons out of pre-quilted cloth, or you can sew your own quilting - simply cut two identical panels, one of the outer and one of the inner fabric, machine stitch rows down them then stuff the rows with whatever you have at hand.
- Cut out, sew and pad arms in the same manner. These can be attached to the body either by hand stitching or by points and ties, which have the advantage of leaving the armpits open and ventilated.
- Add closures down the front (laces or buttons) and arming points; laces to attach your arm and shoulder armour.

Sewing an arming point

1. Work from the right (outer) side of the fabric. Make a circle of stab stitching round the eyelet position; finish by bringing the needle up just outside the circle.
2. Now push a sharp point (scalpel, scissors point, stiletto...) into the centre of the circle and start forcing it through, working from both sides alternately until the hole is almost as big as the outline stitching.
3. Put the needle down through the hole and back out a little further round, whipping over the edge of the hole and the outline stitching. Pull each stitch tightly as you go round. The stitches should just touch as they pass through the hole and radiate out a little.
4. To finish off make one or two small stab stitches from back to front, then lose the end in the stitching at the back. You should have a firm slightly raised ring.

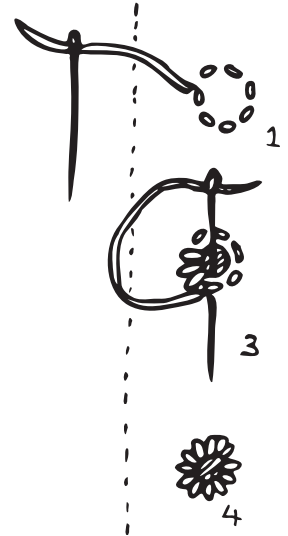

The best thread to use is firm cotton or linen thread, 40 gauge or thicker; synthetic threads fray too much for hand sewing.

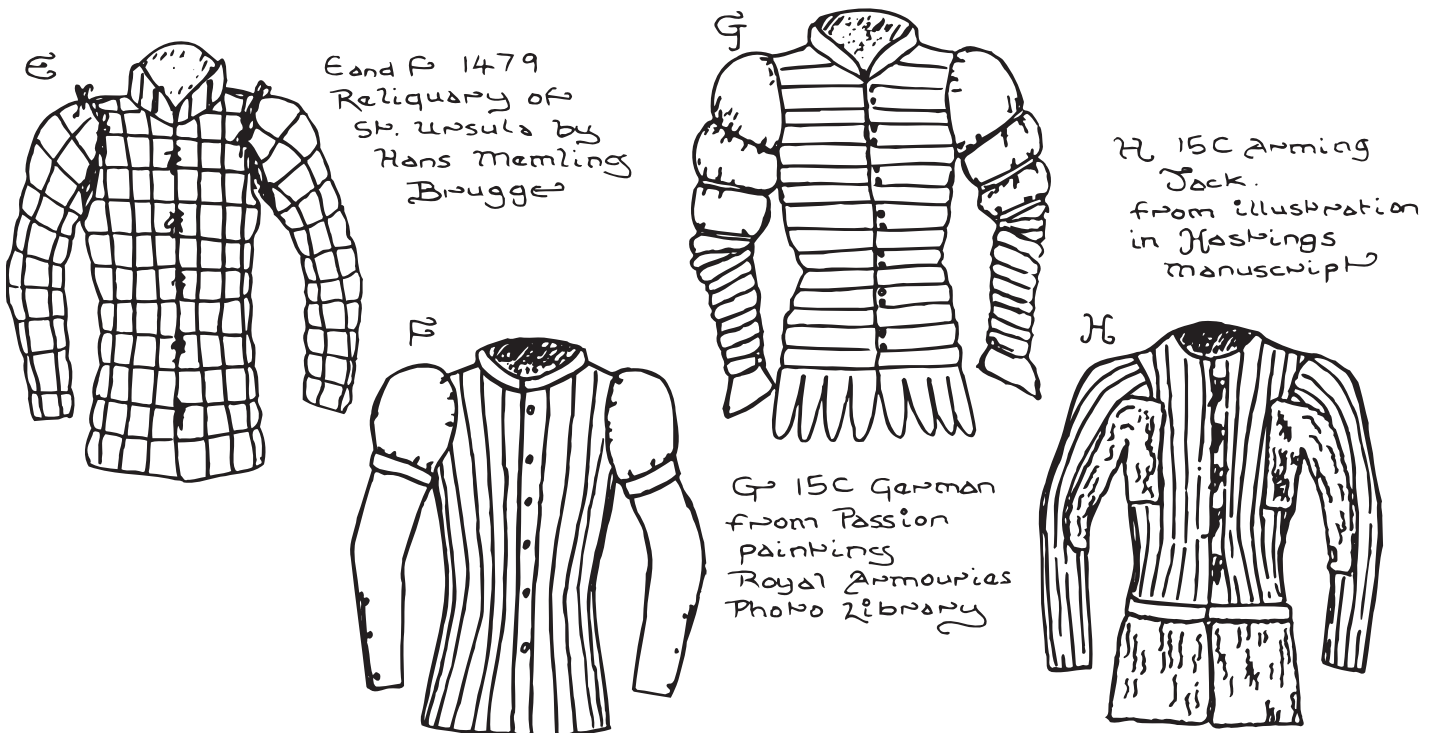

Limb Padding

Armour, by itself, will absorb a portion of any blow hitting it. The purpose of padding it to reduce what remains to an acceptable level; where you don't get hideous bruises but you can still feel the blows; yes you can over pad things! You have two choices; either you allow what is below the armour (gambeson, padded hose, flesh) to absorb the remaining impact; or you add extra padding to the inside of the armour. Felt, leather, or closed cell (backpackers' sleeping mat type) foam can all help, experiment until you find what suits you.

Joint Padding

Joints are susceptible to damage and should therefore be well protected. Extra protection can be built into your under garment; an extra pad worn under the armour, such as one from a sport like hockey or skate boarding; or padding added to the inside of the armour, such as sleeping mat foam. Again experiment until good protection and mobility are achieved.

Helmet Padding

The amount of padding required depends on how hard and how often you expect to be hit on the head. (For further information see Chapter 18.) The way you pad it depends on personal choice, there are three basic ways; line it with foam or felt, build the padding into a coif (close fitting cap) or else build a leather suspension ring like the inside of a modern combat helmet. Of course you can always use combinations of the above. To keep things simple I'll just describe padding for the most extreme case, tourney fighting. For this you need a layer of closed cell (backpacking sleeping mat) foam with either, extra reinforcing pads (made of less dense foam) or a coif.

Padding the Pot and Great Helms is fairly straight forward. Cut the foam to the shape of the individual panels of metal and fit them inside. First put in a layer of closed cell foam against the steel. Then add open cell (mattress or packing type) foam where needed to make a snug fit.

To pad a curved top helm make a liner as follows:

1. Measure the circumference of your helm at about brow level. This gives you your base line. Next measure up from the brow to the crown of the helmet (the top most point). This gives the height. Divide the baseline into four segments and turn each segment into a triangle with rounded edges. Measure the depth of the rest of the helm and add this to the bottom of the triangles. Allow a hole for the face.
2. Cut the resulting shape from closed cell foam. Trim as necessary to get a good fit inside your helmet then duct tape together.
3. Take strips of open cell foam and put a strip across the brow, at the back of the head, at each side and put a disk of foam at the top. Leave plenty of room between strips for air circulation.
4. Try the helm on and see how it feels. Trim padding until a snug and comfortable fit is achieved

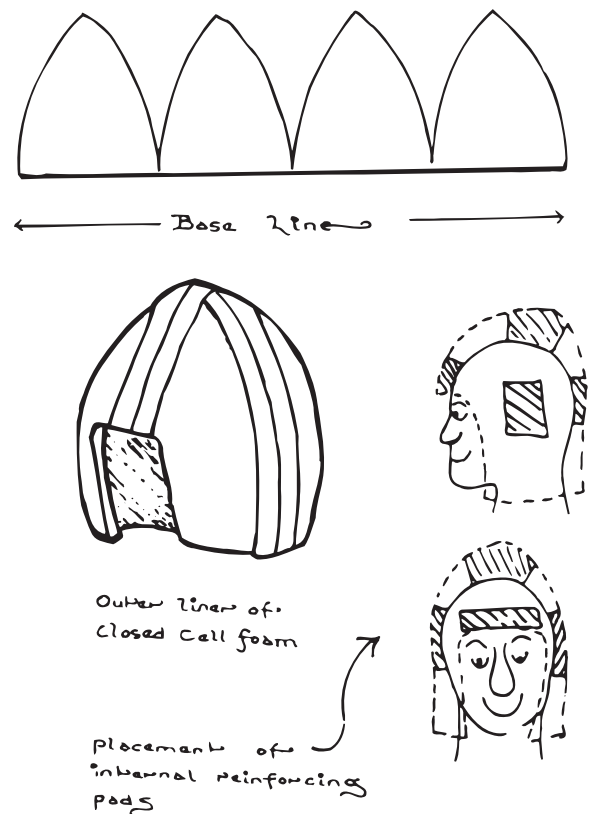

PADDING

Don't glue your padding fully in - you may need to tighten your rivets or take a dent out—try a removable liner or Duct Tape instead.

Gauntlet Padding

Gauntlets tend to be fairly tight fitting leaving little room for padding. Gauntlets, however, don't need much padding as they achieve a lot of their effect by spreading the force of a blow—along the hand, onto the arm and onto the hilt or haft of your weapon. Start with a good pair of leather gloves; quantity welding or gardening gloves work fine. Hold onto a convenient haft and tap your gauntlets. Sting or touch anywhere? Then add a thin layer of felt or back packing foam to this point. Good areas to pad are the fingertips, knuckles and around the wrist guard. Keep padding until it feels right.

PADDING



Chapter 9 — Head

When designing helms beware of gaps between head and neck armour and sword sized holes at the throat! Helmets should be made from at least 16-gauge steel. Making a cardboard template and adjusting this to fit your head, rather than playing with bits of steel, saves a lot of time and effort!

Pot Helm

I designed this helm as an exercise in minimalist cutting—it only has three plates

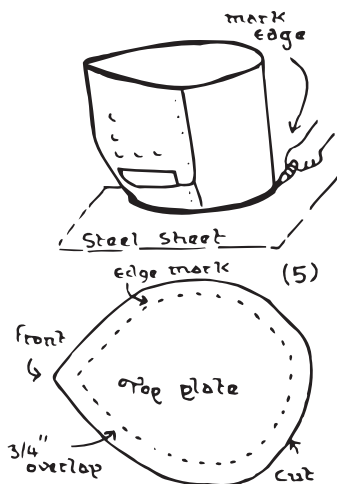
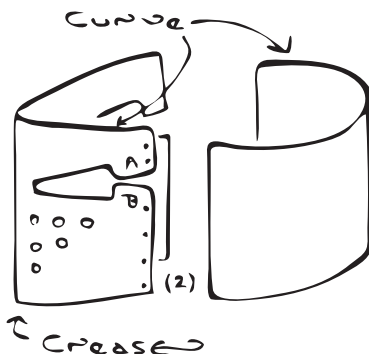

1. Cut the front and back plates as shown on the pattern, figure 9-1. To cut the eyeholes drill a series of holes around the, inside of the slots. Cut between the holes with a hacksaw or cold chisel then file the remaining points back to the marked line.
2. Curve the plates as shown. The crease at the front is simply achieved by bending the plate over a flat edge.
3. Bend the top of the face plate down so that tab B covers tab A. Rivet them together, on both sides, using the holes nearest to the eye slot (don't rivet the other hole yet). Pein rivets on inside of helmet.
4. Rivet the front plate over the back plate. The front plate should reach the line labelled *overlap* on the template. Don't rivet the very top of the helm, or you won't be able to get the top plate on! You can use one of the lower rivets on each side to hold a chinstrap in place.
5. Turn the helm over onto the steel sheet and trace around the outside of the helm. Add about 2 cm

finished
Helm

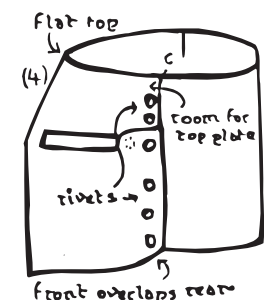
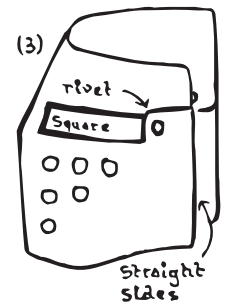
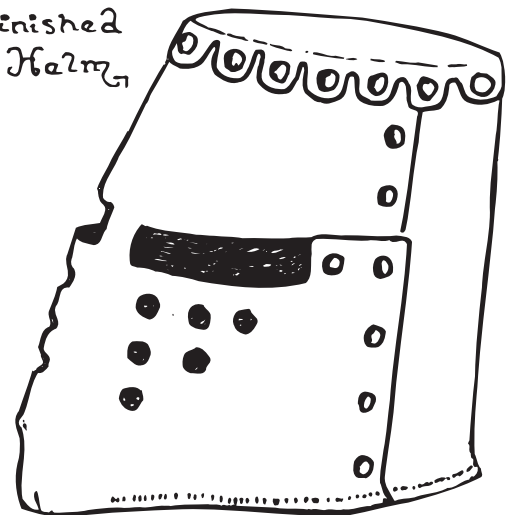

HEAD

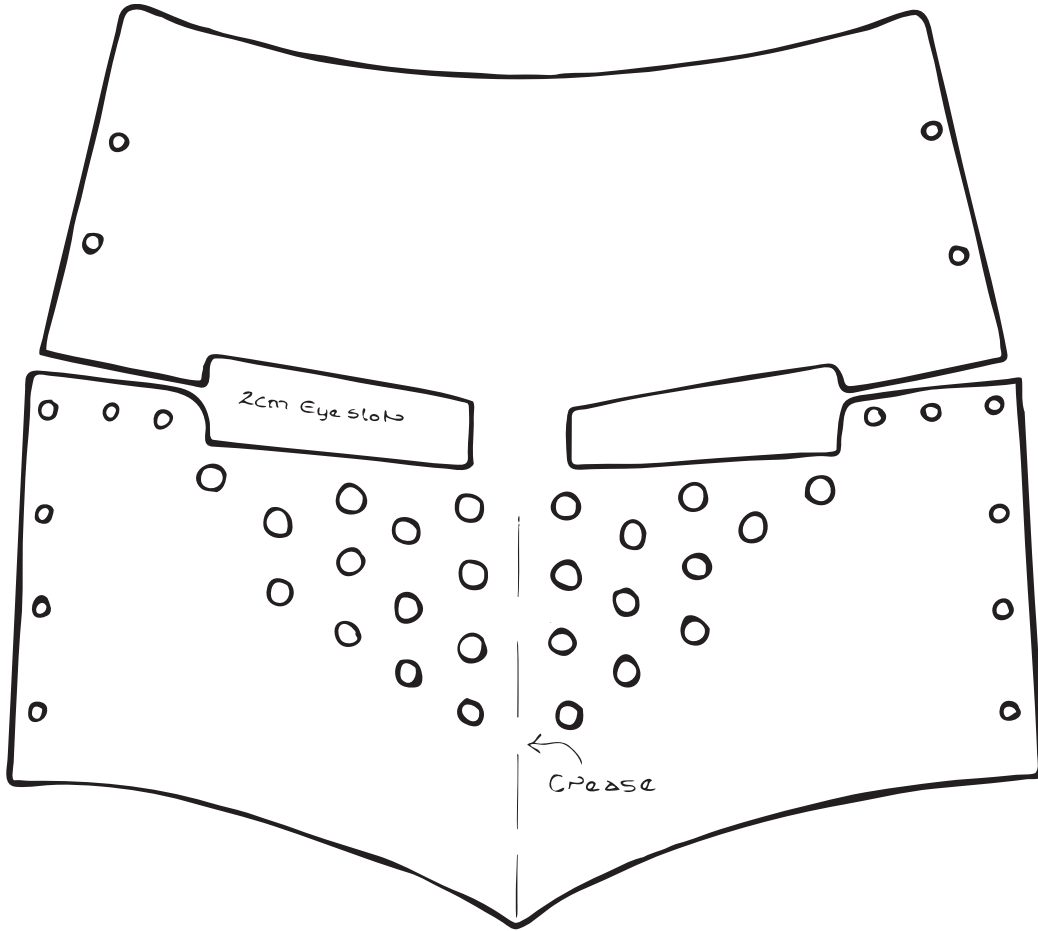

Back Plate

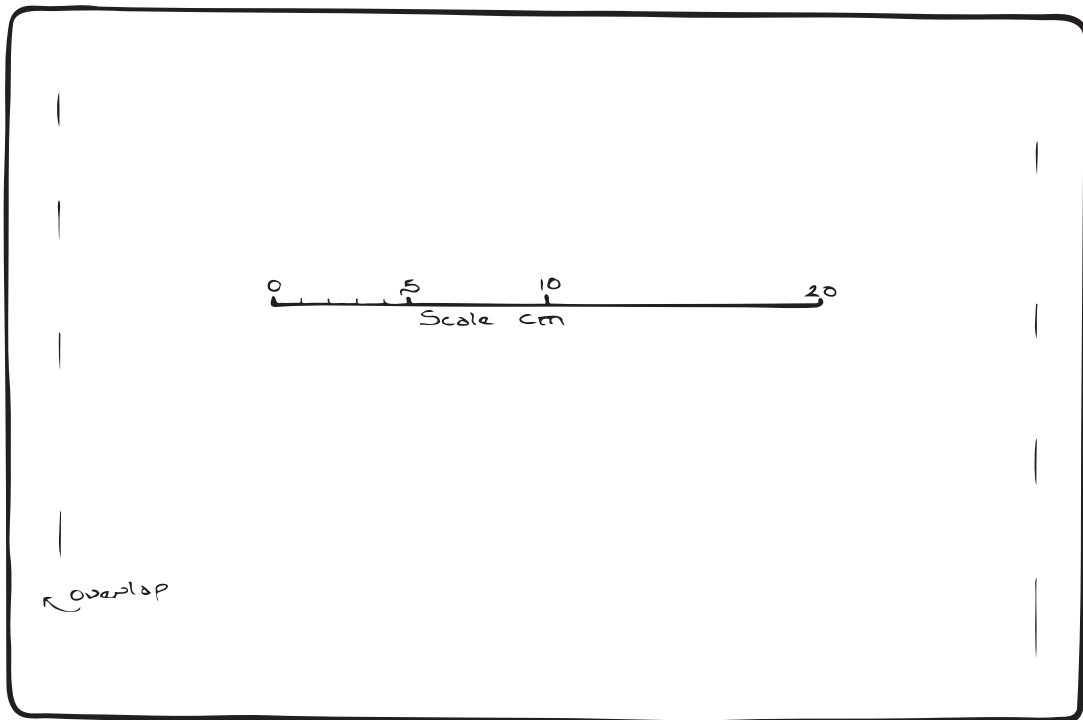
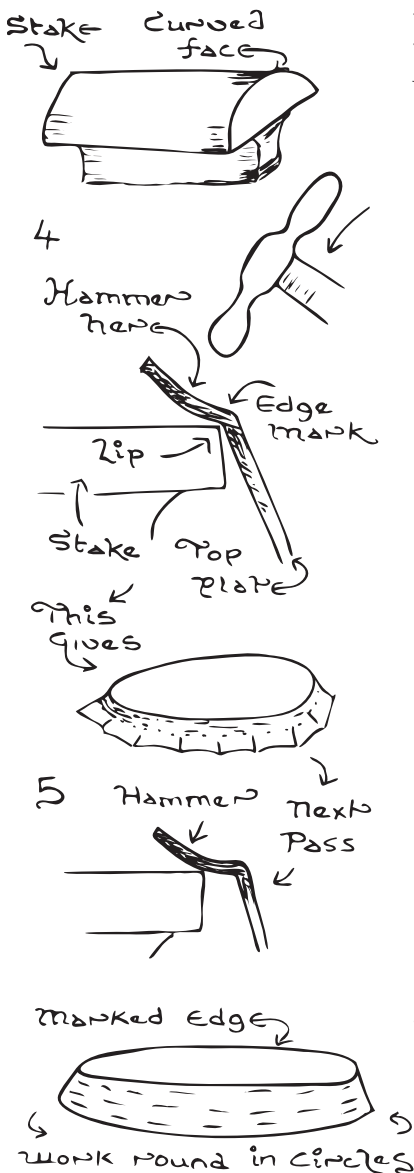
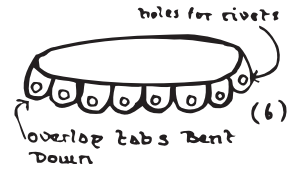

Figure 9-1: Pot Helm Pattern

HEAD

overlap to this and cut the resultant shape out. This is the top plate for the helm.

6. Make a series of evenly spaced holes, 1 cm from the edge, approximately 3.5 cm apart around the circumference of the top plate. Cut around these holes, up to the edge mark line, so as to turn the overlap area into tabs. Using a soft face hammer bend the tabs down so they touch the sides of the helm.
7. Place the top plate on the bottom plate and rivet them together through the tab nearest the front crease. Next rivet the tab at the rear and then one tab on either side of the helm thereby holding the top plate evenly in place.
8. Rivet the rest of the tabs. The Tab method is the easiest way to fit the top plate; an alternate method, using less cutting but more hammering, is to raise the overlap down (see Raised Helm Top).
9. Curl the back edge and sides of the helm to prevent them hitting your shoulders.
10. Pad inside of helm - especially the top, these helms made great "mace landing pads!"



Raised Helm Top

Want even *less* cutting? Then raise the top plate edge over:

1. Turn the helm over onto the steel sheet and trace around the outside of the helm. Add about 2 cm overlap to this and cut the resultant shape out. This is the top plate for the helm.
2. Mark the overlap onto both sides of the plate. Draw a few intermediate lines on the outer surface.
3. Cut a 2.5 cm wide groove into a thick piece of wood. Using this as a former beat the overlap into V shaped crinkles.
4. Take a raising hammer (a cross pein with the back smoothed will do) and a convenient stake (ideally with a curved face and a flat end). Place the top plate onto the stake so that the marked edge is at the lip of the stake. Strike the overlap, immediately next to the marked line, so as to force the metal at this point down onto the surface of the stake. This will force the metal inwards. Strike in an identical manner evenly all around the top of the overlap until you come back to where you started.
5. Move the top plate further out (this is where those intermediate lines help) and hammer another circle down. Repeat this process hammering further out

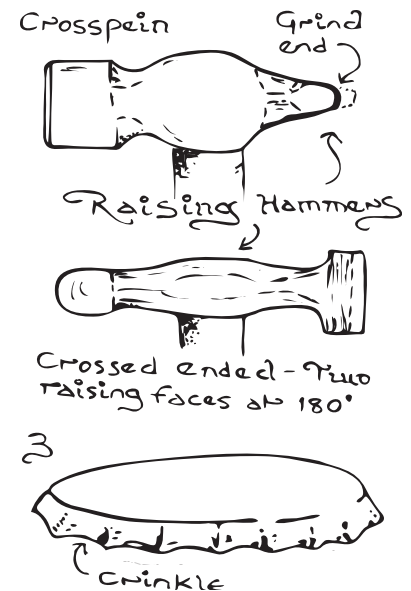

HEAD

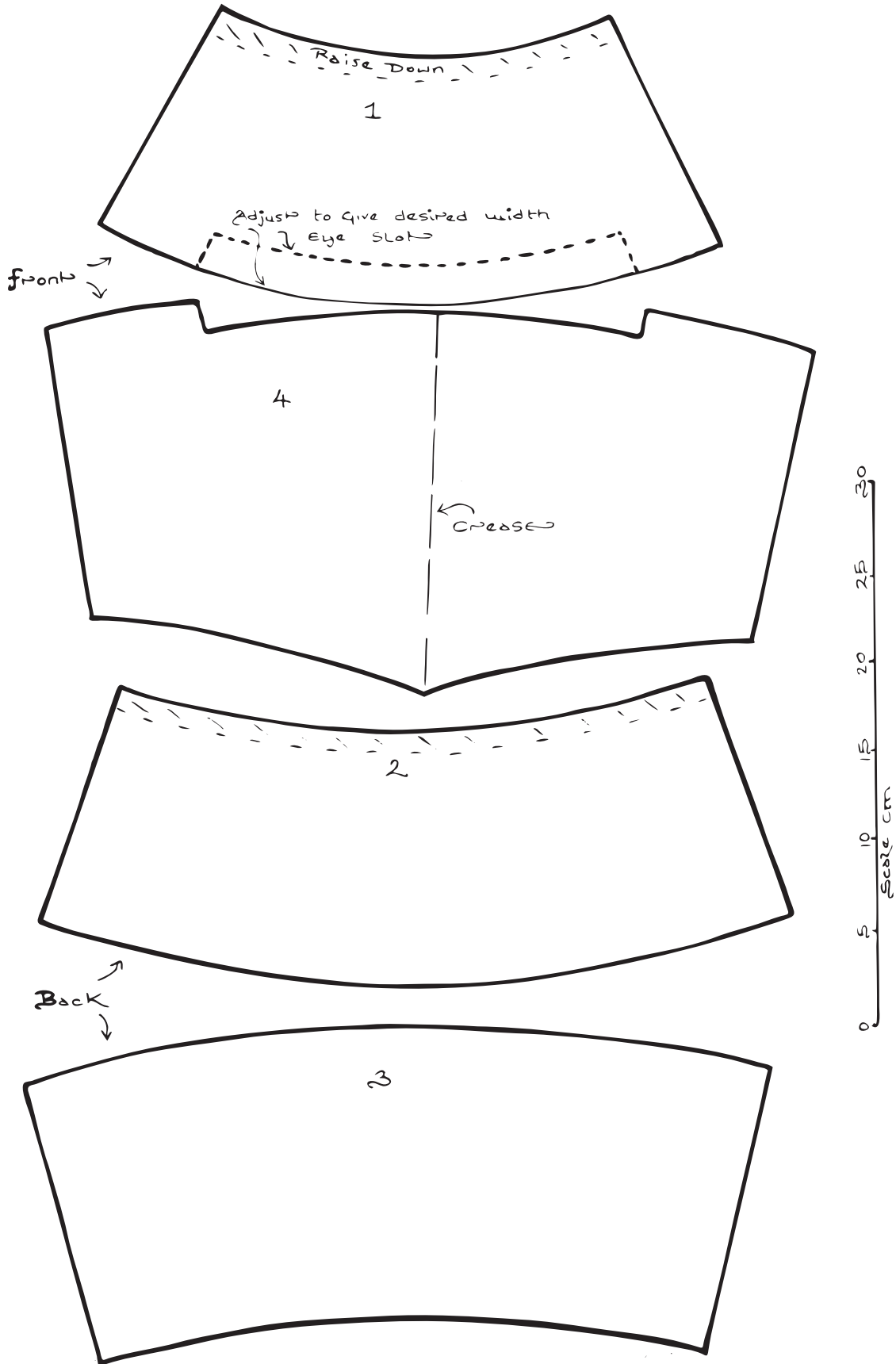
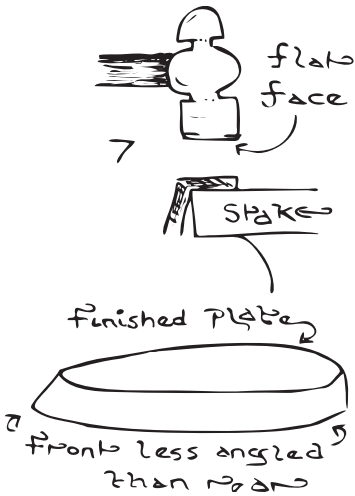

Figure :

HEAD

each time until you reach the far edge of the overlap. This is one pass; now anneal the piece.



6. Starting at the inner edge each time do enough passes to bring the overlap into the correct shape to fit the helmet top. Note: you have to raise more at the back than at the front.
7. When the plate is the right shape planish the hammer marks out by placing the lip over the stake and striking it evenly with a flat faced hammer. If the top plate is not entirely flat, a likely event especially on your first try, place it upside down onto a flat wooden surface and beat it into a better shape. Hammer or file the lower edge until it is even.
8. Rivet in place. Enjoy.

Great Helm

This helm can use either of the last two methods of attaching the top plate or the method given below. Isn't choice a wonderful thing?

1. Scale up the templates over page to fit your head, transfer them to steel then cut them out.
2. Crease the centre line of plate 4; curve the plates to the shapes shown bellow.

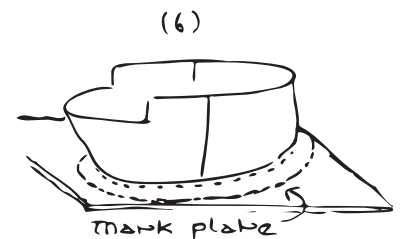
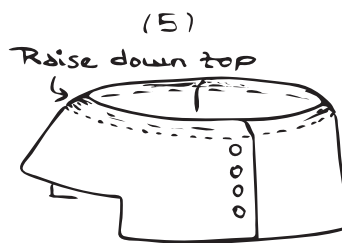
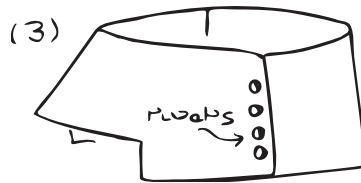
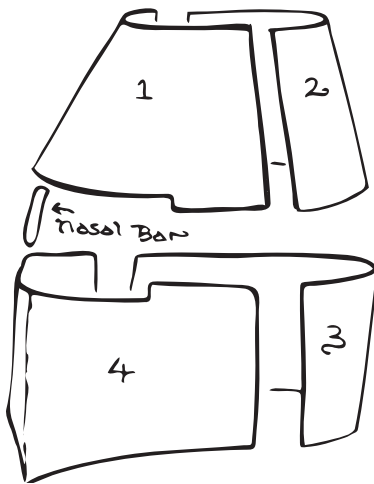
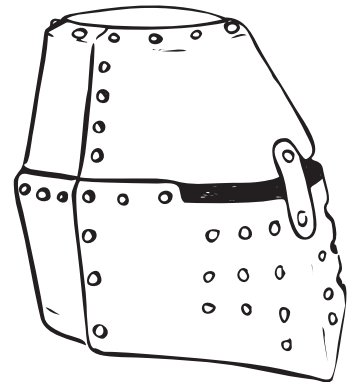

3. Make the upper half; place plate 1 over plate 2 with a 20 mm overlap and rivet them together with four rivets. Leave room for rivets at the top (for the top plate) and at the bottom (for plates 4 & 5).
4. Check that the upper half fits your head; it will be difficult to change after the next stage! It should be slightly egg shaped (I've yet to meet anyone with a round head.)
5. Mark a circle 20 mm down from the top of the upper half then raise/bend this in a little.

HEAD

6. Turn the upper half over onto the steel sheet and trace around the outside of the helm. Add about 2 cm overlap to this and cut the resultant shape out. This is the top plate for the helm.
7. Dish the top plate to meet the raised curve on the upper half. This shouldn't be an extreme bowl shape, just a gentle curve. Rivet the top plate inside the upper half.

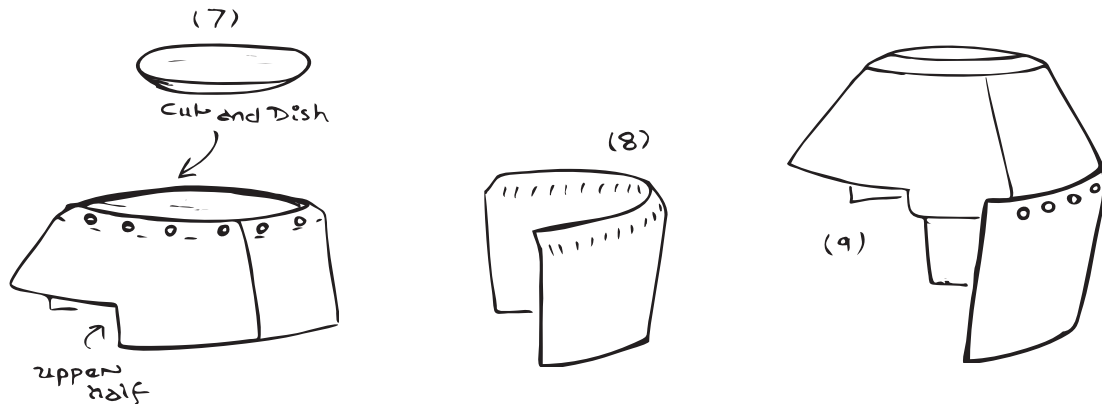

8. Take plate 3 and curve the upper edge inwards a little by hammering it over a suitable former.
9. Rivet plate 3 to the rear of the upper half. Don't rivet at the very end because you will need this space to rivet the front plate on! If you rivet the two ends then the middle you can adjust the shape of the overlap, with a suitably large hamme, to ensure a good fit all round for the rest of the rivets.
10. Bend the two tabs on plate 4 inwards so that they match the curve on the bottom of plate 1 then rivet the plate to the rest of the helmet.
11. If necessary file the eye slot to give an even gap. Cut a small nasal bar and rivet it across the centre of the eye slot. Pad and enjoy.

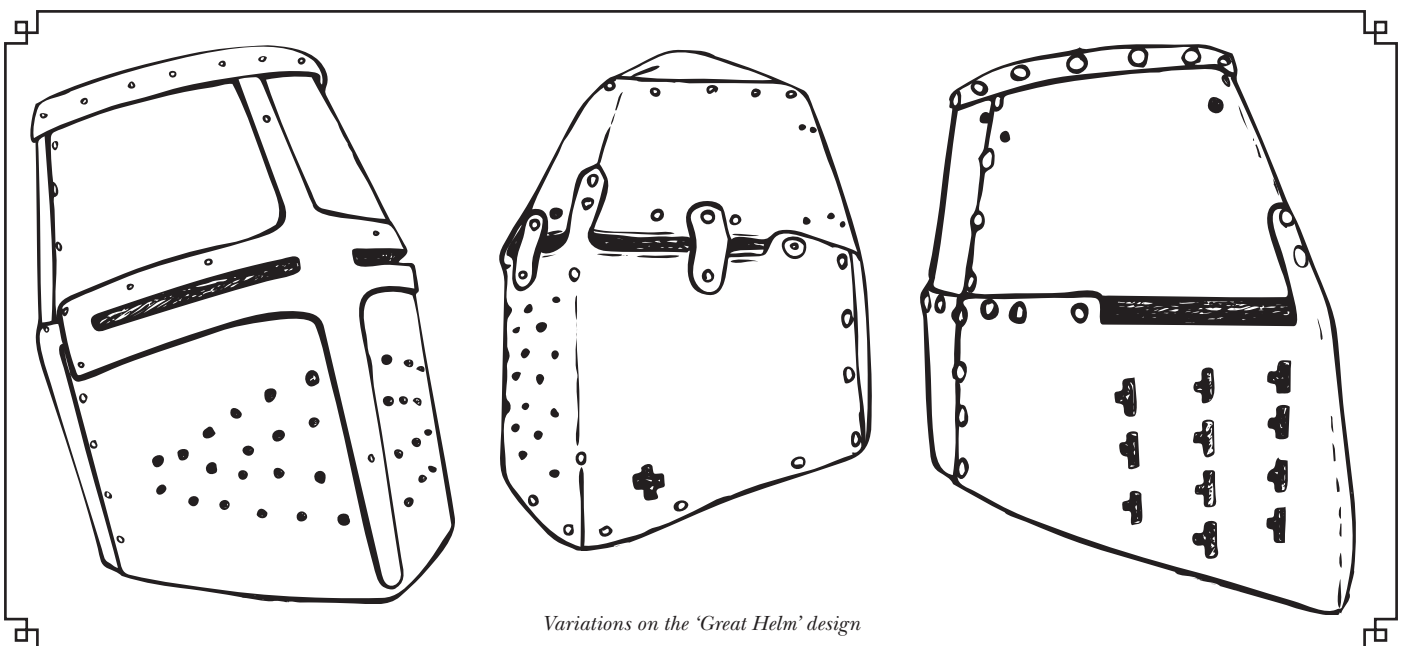

Variations on the 'Great Helm' design

Breaths and Eye Slots

The breaths, being the holes/slots in the front of the helmet, serve several purposes; the primary one being to allow you to breath! Breaths also allow you to see downwards without moving your head and give your sweat a chance to escape. Period helms often had the breaths on only one side, useful for preventing lances gaining a grip during a tourney but detrimental to ventilation and vision. I would suggest holes on both sides, under the eye slot and around the nose and mouth area. The cheek and chin areas will more than likely be covered by padding so don't extend the holes too far around. When drilling breaths remember to remove the burrs from the inside of the helm! You can drill/cut the breaths before you rivet the face plate on.

Dome Topped Helm

Variations in design will allow this type of helm to be used for a wide variety of periods and fighting styles.

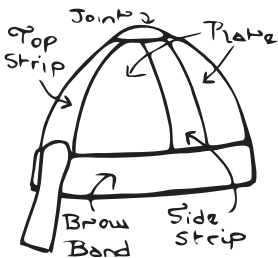

Two basic frame designs are described below - many more are possible, however, the logic behind them remains the same. A *brow band* goes around the head. Strips are attached to this, which pass over the head from back to front and from side to side, to form a frame. Dished side plates are then inserted into the frame to form the dome. Additional pieces are then added to give face, cheek and or neck protection

Crusader Style

This frame design has a relatively shallow brow band and narrow frame strips. The top of the frame comprises a back and front strip and two side strips, which are joined at the top by another small plate at the top.

1. Decide on the details of the design.
2. Measure around your head, add a bit for padding (see Chapter 18) and use this to make a template for the brow band.
3. Measure across the top of your head, and again allowing for padding, cut templates for the back and front strips and the joining piece. Tape the templates together, bend into an egg shape to fit your head then use this to work-out the size of the sidepieces. Here are a few useful tips:
 - a) A 2 cm overlap gives space for riveting. The strips all need this at both ends.
 - b) Because your head is oval, not round, the side strips will be shorter than the front/back ones.
 - c) Having all the strips the same width makes cutting a lot easier!
 - d) Make the strips longer to achieve a more pointy look.
4. Transfer, then cut, the patterns from steel.

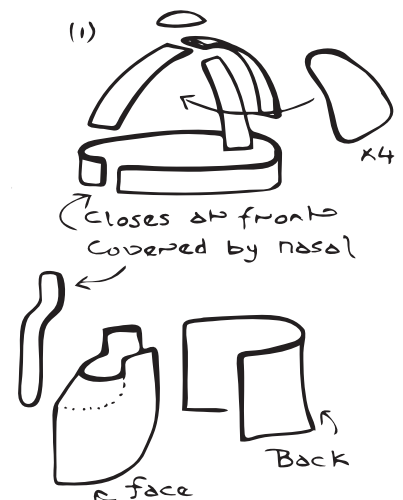

HEAD

5. Mark the back point and centre side points on the brow band; use these to mark the rivet hole positions for attaching the frame strips then drill the holes. Bend the brow band to shape.
6. Bend the frame strips to shape; if they are wide you will have to dish them a bit. Dish the joining plate.
7. Match the frame up, use the holes in the brow band to mark the rivet hole positions in the strips. Drill holes in the strips and joining plate.
8. Bolt everything together. You now have the basic frame shape.
9. Place a piece of card inside one of the holes in the frame and draw round the hole. Remove the card, add enough space all round for rivets (a couple of centimetres or so) and you now have a template for your filler plates. Note that the sides of the filler plate are not identical, this means a front plate is the mirror image of a back plate.
10. Cut four filler plates then dish them to fit the holes. Make sure you dish the right side for the plate to fit, see note above! It helps if you number them—this way they don't get mixed up.
11. For each plate:
 - a) Remove bolts from around hole then place plate inside. Check the fit; re-dish/planish until happy.
 - b) Mark the rivet hole positions through the frame. Remove the plate then check the holes are in sensible places i.e. not right next to the edge! If necessary refit.
 - c) When satisfied with fit cut off any excess metal from the filler plate (more than 1 cm from the rivet line) then drill a few of the holes (a couple top and bottom is good).
 - d) Rivet the plate in place.
 - e) Drill and rivet the other holes. You can try and drill all the holes before you fit the plate but I find inaccuracies in marking and drilling move things enough so that after riveting a few holes the rest no longer quite line up.
 - f) The dome is now finished.
12. Cut out a back plate, if required—the illustration this comes from shows a front plate and mail worn over the rest of the head to protect the back and neck. Curve the back plate then dish out the bottom to give the shape shown. Rivet this in place. If you want an early period look cover the back plate with leather.
13. Cut out the front plate and drill breath holes. Curve the plate then dish the top (below eye) section in.
14. Cut nasal bar. Rivet front and back plates in place. Doing them together allows you to sort out relative positions, overlap and other such problems. Rivet nasal bar in place, add chinstrap, pad and wear.

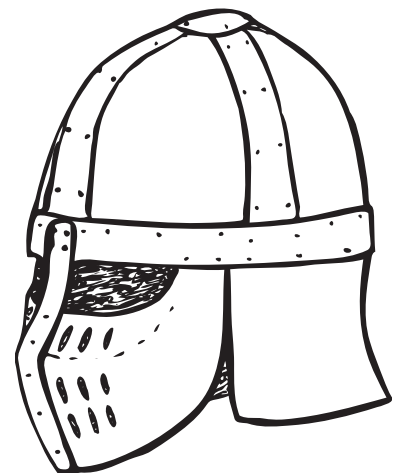
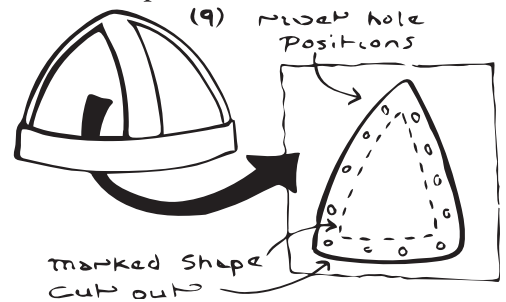

Coppergate Style

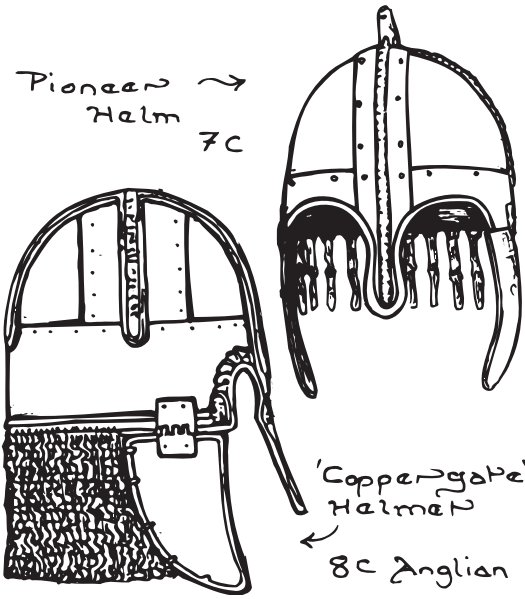

This frame design has a deep brow band with eye holes cut into it, a single strip passing from front to back and two side strips which rivet under the front-back one.

Dome construction is the same as for the previous helm except:

1. Measure across the top of your head, and allowing for padding, cut a template for the top strip. Tape the top strip and brow band templates together then use this to work out the size of your sidepieces. Note that the *mid point*, where the side strips joint the top strip, is not in the middle of the top strip! This is

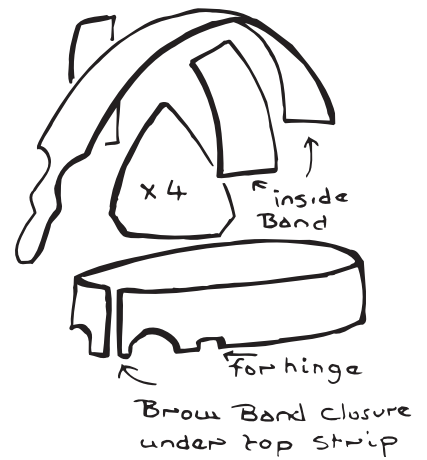

because the front, especially if it has a nasal overlaps the brow band more than the back. If you mark the positions of the top of the brow band onto the top strip then the mid point is halfway between them.

2. The strips are wider on this design and so will need to be lightly dish/bend to shape.
3. The front of the top strip goes over the brow band; everything else goes under.

The original helm has some very ornate brass work over the top and on the nasal, hinged cheek plates and mail at the rear. If you wanted something less open you could add a face plate and neck guard in the Sutton Hoo style.

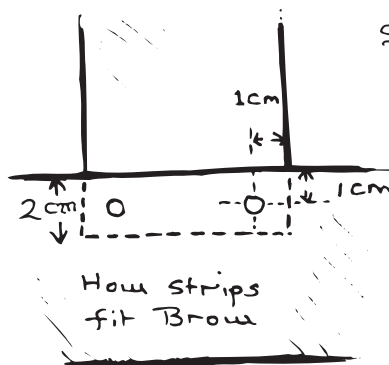
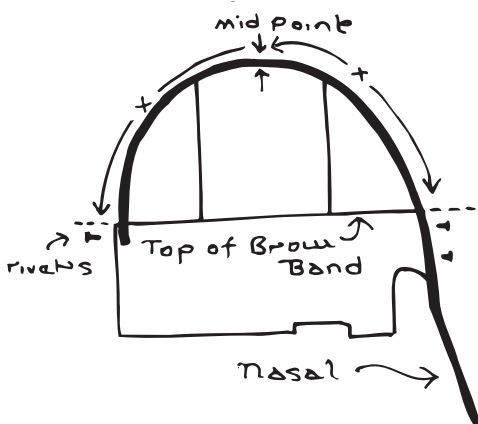

Sutton Hoo 7c

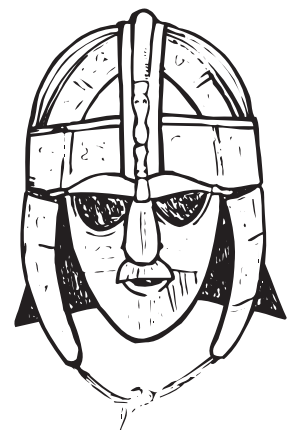

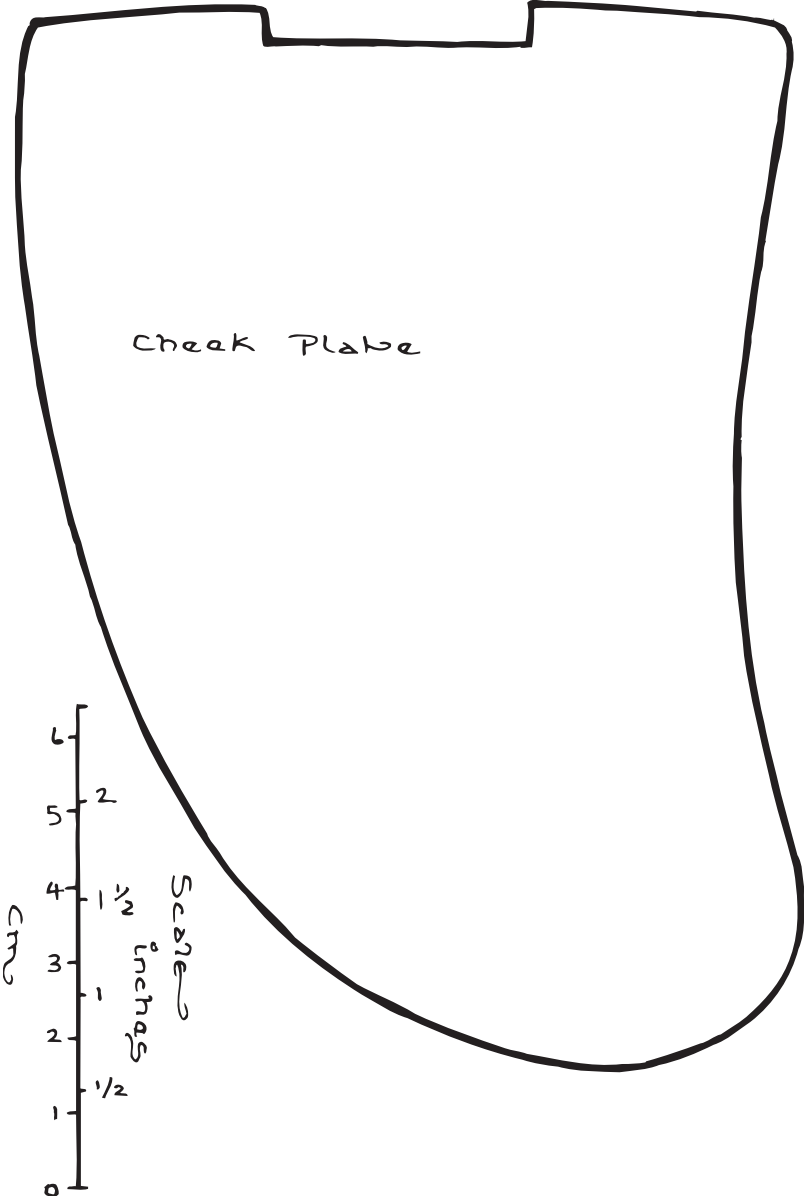

Figure 9-3: Cheek Piece Template

HEAD

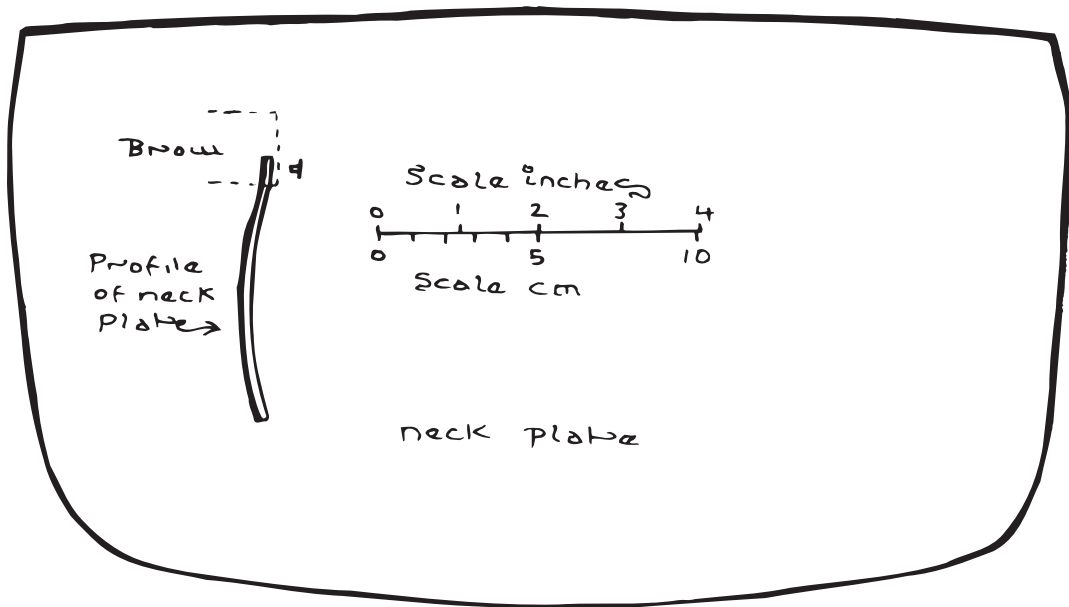
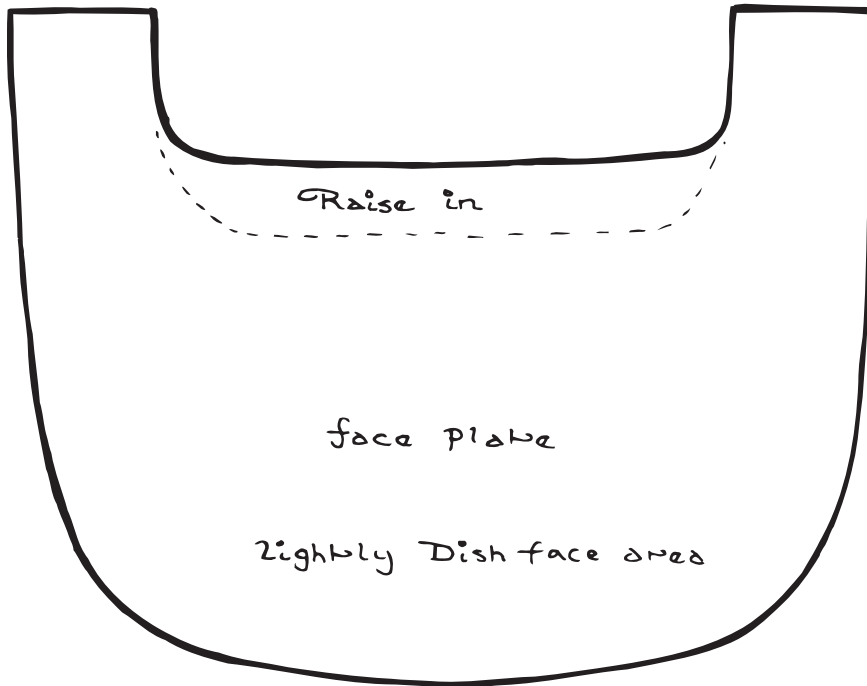
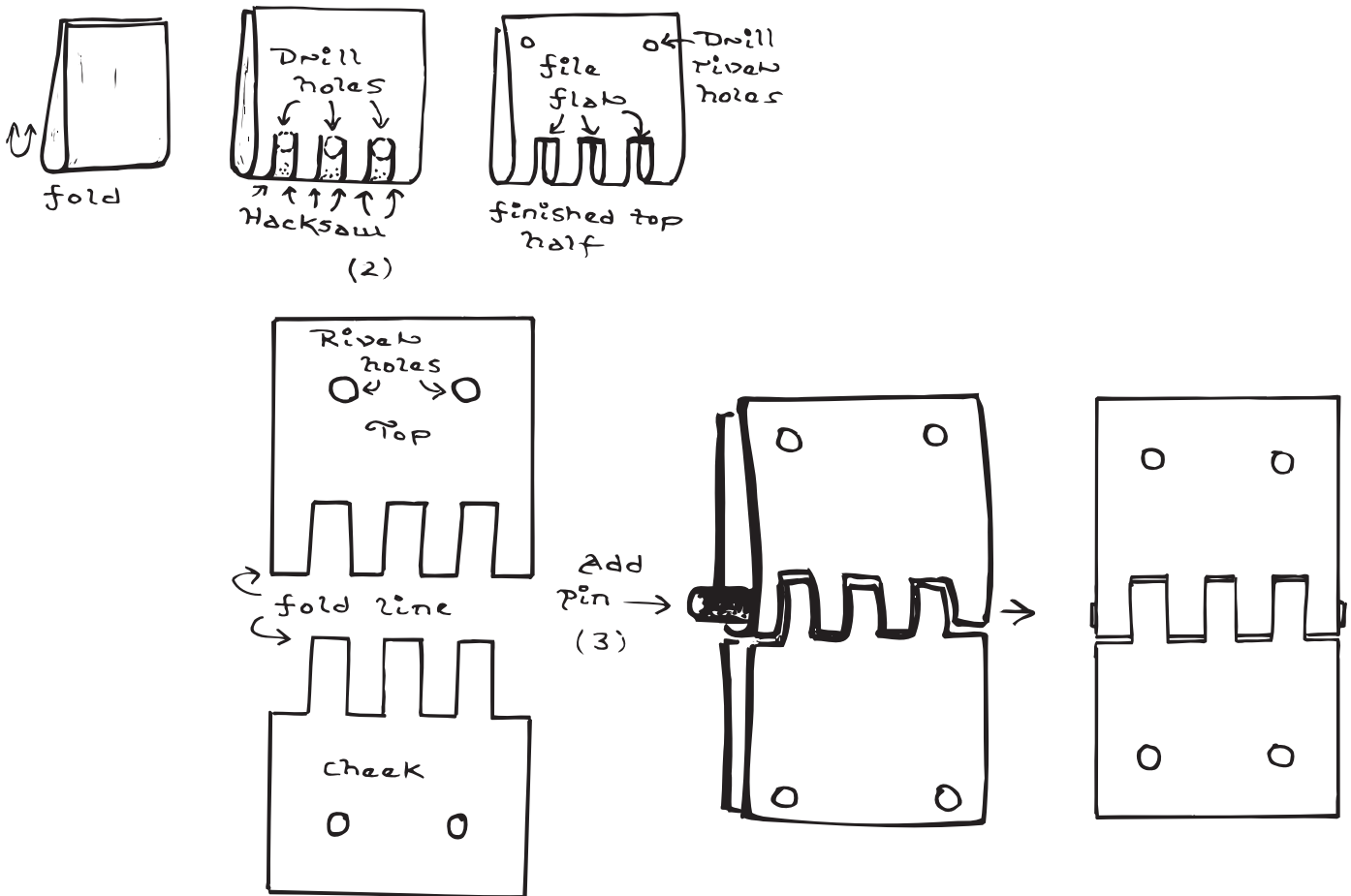
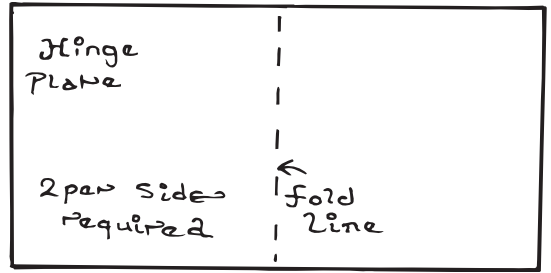

Figure 9-4: Dome Topped Helm Templates

Hinged cheeks

1. Cut out and lightly dish the cheek pieces.
2. Take a strip of metal (about 3.5 cm wide), cut in half then fold each half in two over a rod. Hacksaw/file as shown. Drill two rivet sized holes through each half.
3. Cut a piece of rod the same width as the strip to form a *pin*. Cut a slot into the top of cheek piece and the brow rim to fit the hinge. Join the two halves of the hinge, insert the pin then rivet onto helm and cheek piece. You don't need to peen the pin as the slots prevent the pin falling out.



Chin Strap

The chinstrap is a very important part of the helmet—it keeps you from eating the faceplate when a spear hits you! It also keeps your helm from doing embarrassing things like popping off in a melee! A split chinstrap is the most comfortable to wear; for anchoring it a double strap is most effective. The straps should be attached to the helmet just behind and above the ear.

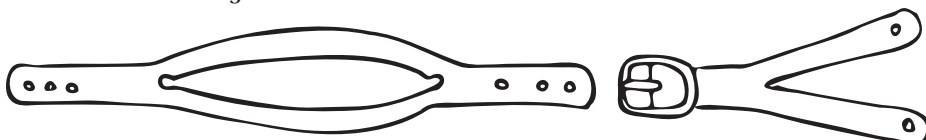
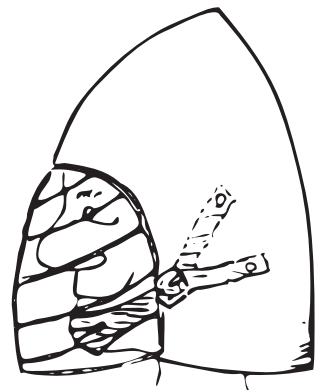



Chapter 10 — Neck

There are several vulnerable areas around the neck. The front of the throat is open to spears, halberds and other thrusting weapons, the side of the neck may take a misaimed head shot and there is a little bump at the back of the neck that can leave you paralysed if it gets hit hard. Body armour, including a gambeson with a collar, can help protect some of these areas but specific armour is best.

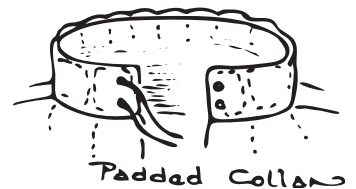

Leather Gorget

This is a simple neckband with added protection front and back.

1. Size then cut out the shapes shown from thick leather. The neckband goes all the way around the neck—only a small bit is shown on the template to save space!
2. Rivet the three parts together and add a buckle.
3. If you don't have a collar on your gambeson pad the neck area.
4. Wear under your body armour.



Bevoir

A popular style from the fifteenth century. A bevoir should be shaped to fit your neck, face and nose (which it should miss!) and the lower part of your helm. Designs vary from ones that cover most of the face to the relatively small one as described below.

1. Cut the neck plate from steel; don't worry about the other one yet!
2. Dish the front, in the area shown. Bend the sides around to fit your neck, then bend them in a little more as forming the lip tends to straighten them out a bit. As you dish the metal below the marked area it will begin to crease; don't attempt to flatten it, just push it down to start forming the lip.

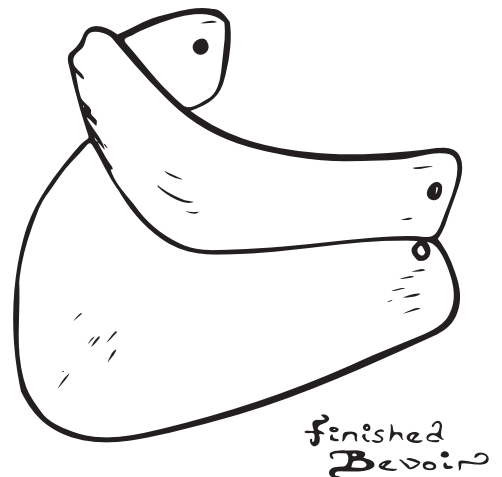

NECK

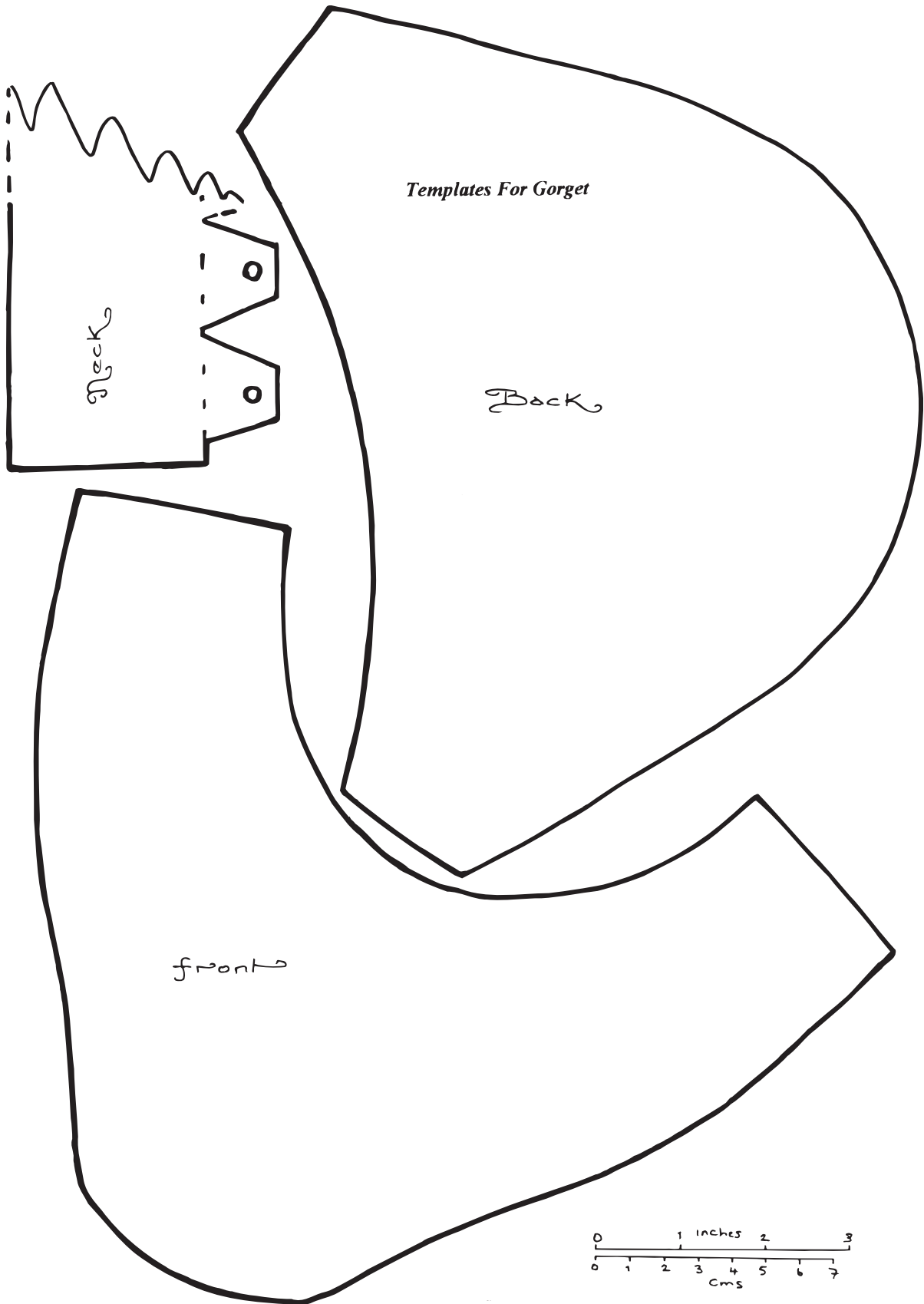

Figure 10-1: Template For Gorget

NECK

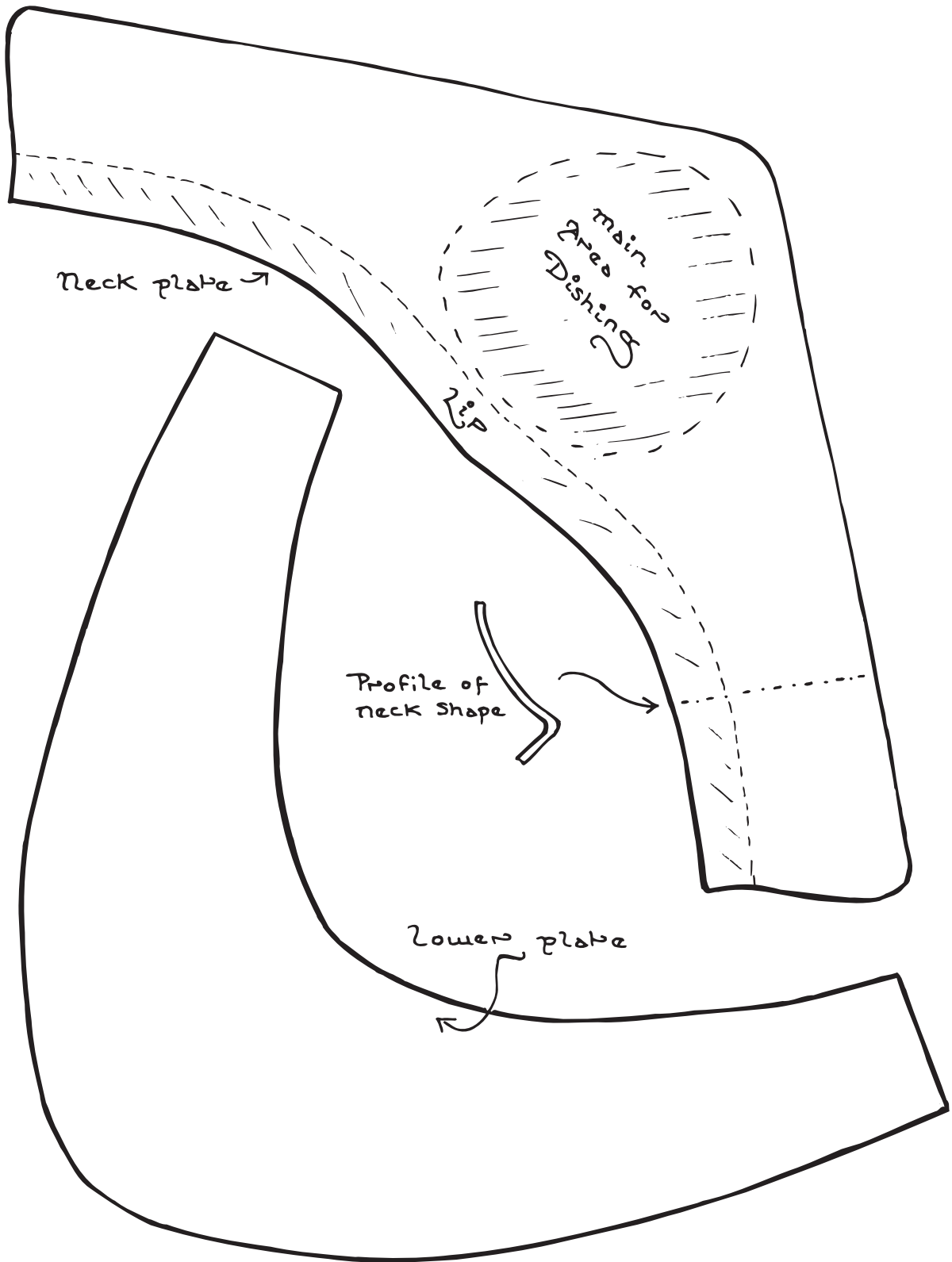
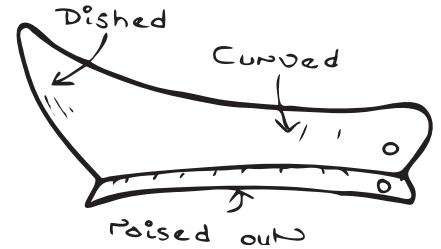

Figure 10-2: Template For Bevoir

NECK

3. Raise the lip to fit your shoulders/top of chest. Don't raise it too far so it sticks up in the air! Dish the sides of the neck plate to give the profile shown.
4. Now take a piece of card and make a template for the lower plate. Take note of how the card bends to accommodate both the neckpiece and your chest - because you are about to copy this in steel. If your bending/raising was a little uneven mark which way up the lower plate fits on the template!
5. Cut the lower plate from steel then bend to fit the neck plate.
6. Loosely rivet the two pieces together then add a strap and buckle.



Bevoirs

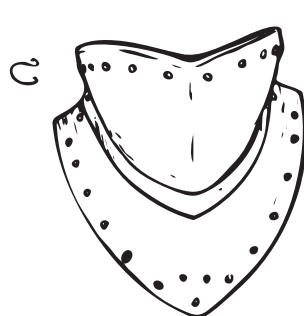
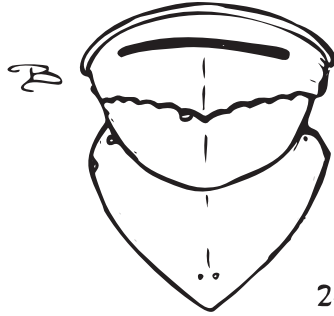
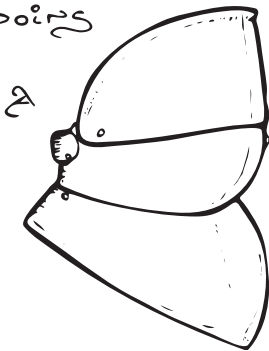

24

A Spanish? c.1500
3 plates

B West European
late 15/early 16C
note eye slot!

C West European
c.1490-1500
one upper, two lower
plates

Notes

Adding an additional upper plate can increase the face coverage of the Bevoir. If you take this to the extreme you can even cut an eye slot in it! The flexibility of the lower plate can be improved by making it in two parts.

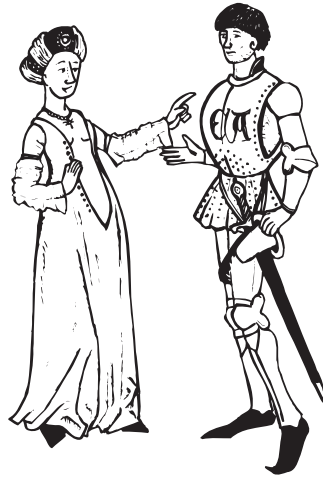

Chapter 11 — Body Armour

Particularly vulnerable areas on the body are the kidneys, groin, spine, collar-bone and ribs. Under the armpit hurts too but I've yet to find a way of armouring there!

Kidney belt

This is simply a wide leather belt that covers the kidneys and some of the lower back and stomach. A less wide version can be worn under other body armour to act as extra protection over the kidneys. It also makes a convenient thing to hang your leg armour off.

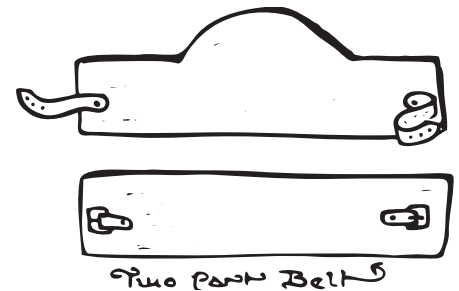

Coat of Plates

Excavation of graves from the battle of Wisby in 1361 revealed a number of *Coats of Plates*; a popular fourteenth century style of body armour often worn as re-enforcement over mail. The design given here is based on Wisby number 6 (the simplest) with the tie loops from number 1 to make it more comfortable to wear. If you look up the reference in Chapter 20 you can get a lot more patterns! The plates mount onto the inside of a *coat*, shaped a bit like a Poncho, which goes over the head and buckles at the back. This simple style leaves the top of the spine exposed but you could always add an extra plate or two to cover things there!

1. Make the coat. This can be cut from leather or sewn from canvas with a material covering on the outside. The coat should be fairly sturdy—its going to take a beating!
2. Cut out and shape the plates. These can be made from thin steel, thick or Cuir Bouilli leather or thermo plastic. Note how the indi-



Wisby # 7 ~ who says they have to be plain and unadorned?

BODY ARMOUR

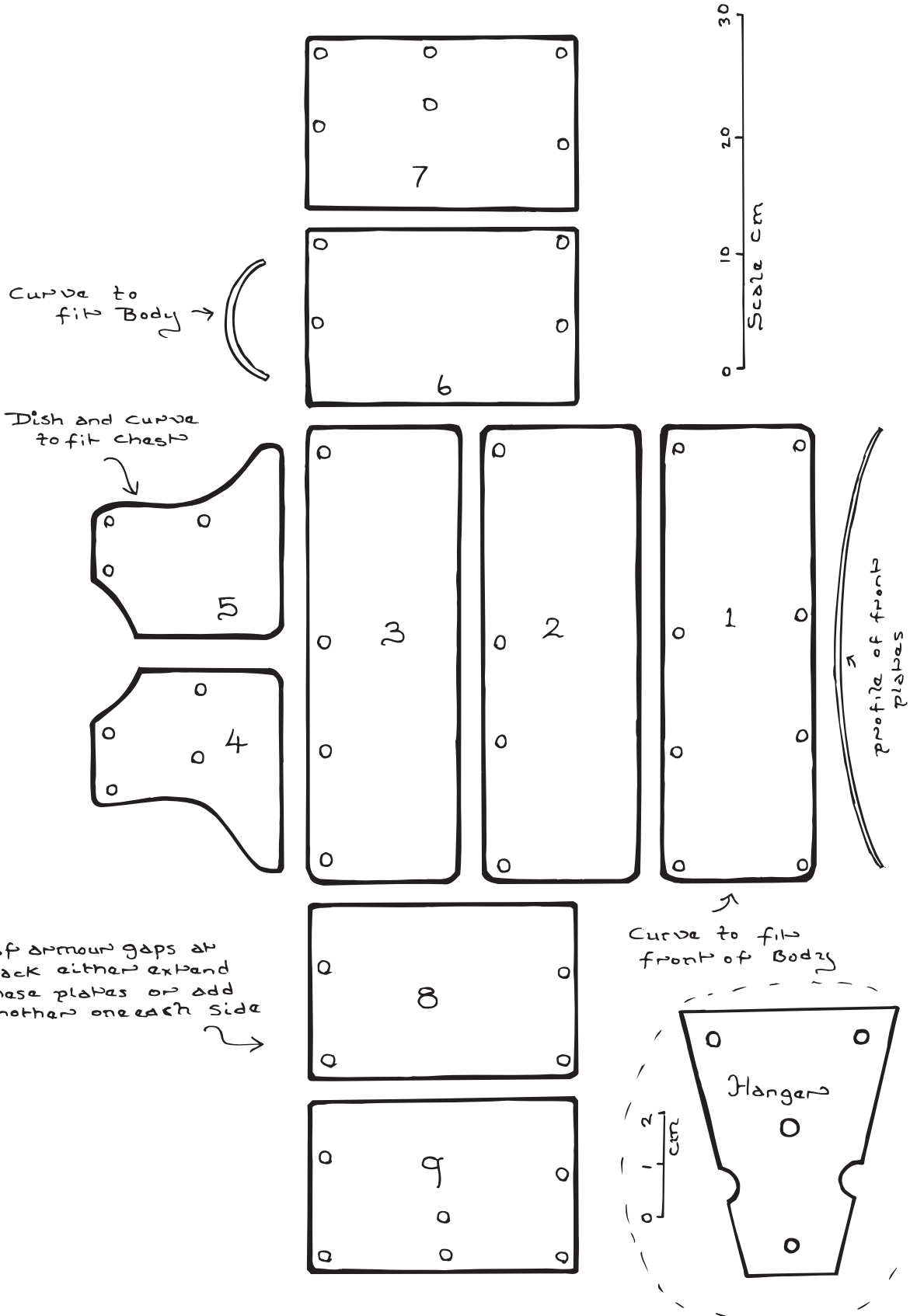
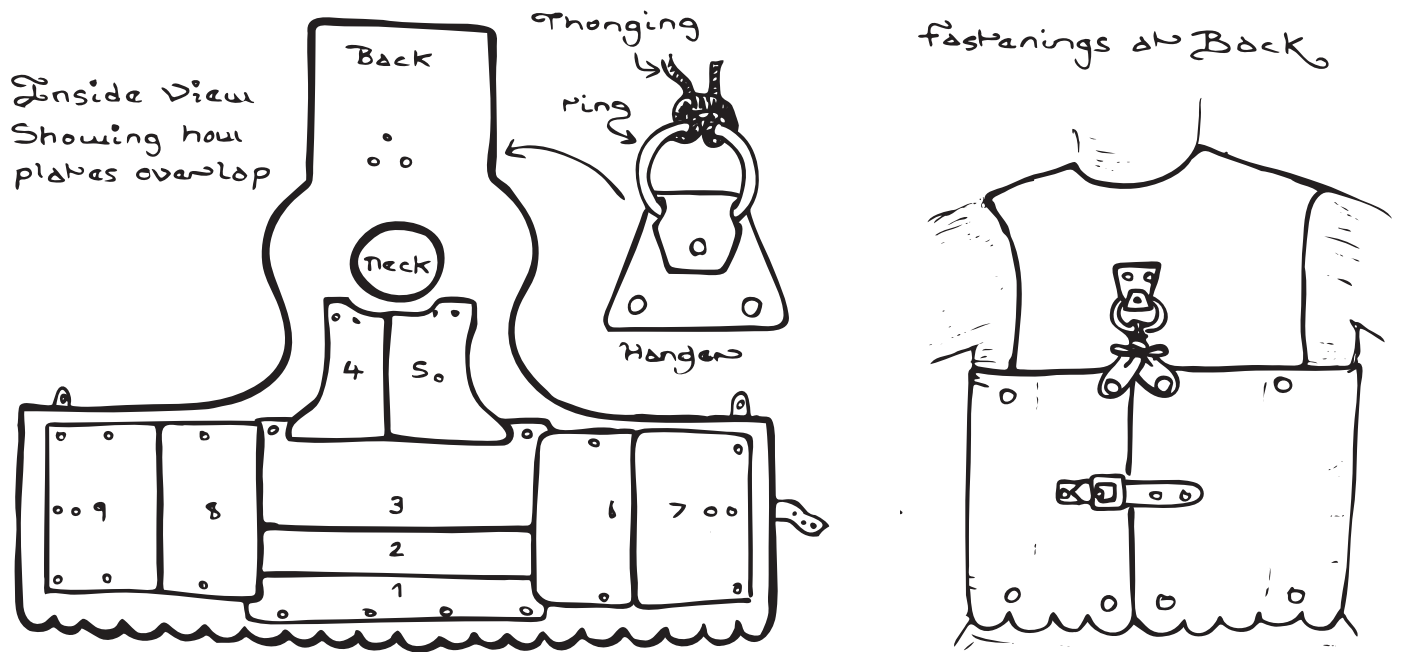

Figure 11-1: Coat of Plates

BODY ARMOUR

vidual plates and the rows overlap, coats of plates work by spreading the force of an impact over several plates.

3. Drill rivet holes in plates. Rivet the plates to the inside of the coat in numerical order. Remember, if the rivet holes on a plate will be covered the plate needs to be riveted on before the covering plate! The rivets can be plate or as ornate as those on armour number 7.
4. Rivet the straps and tie loops in place; a key ring makes a good circular attachment point for the laces.



Brigandine

A front opening style of body armour popular in the 15C. If you are not wearing mail it's a good idea to add *tassets*, plates covering the hips, using the diagram in figure 11-2. This design is based on one found at Chalcis and gives very good overall protection. As with the Coat of Plates, the plates can be made from thin steel, thick or Cuir Bouilli leather or thermo plastic. Making the shoulder plates of leather makes it more comfortable to wear. Rather than show patterns for lots of very similar plates I've simply given an internal view of the completed coat then the dimensions and shapes of a few of the plates. To size the coat to fit first measure your body length and circumference then scale up the diagram, in figure 11-3, to these dimensions. From this, and the diagrams, in figure 11-4, you should be able to work out the various plate sizes.

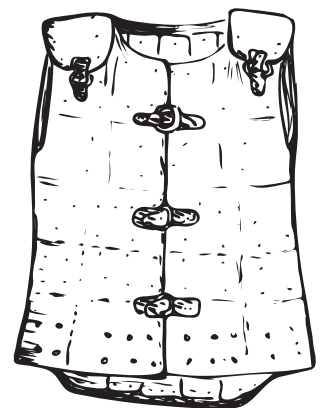

1. Sew the coat from cloth and canvas or cut from leather. It opens at the front and at both shoulders.
2. Cut and shape the plates then drill out the rivet holes; the original has six rivets per plate, four will do. Note that many of the plates are the same size. Numbering them after shaping saves a lot of confusion!

BODY ARMOUR

3. Now rivet the plates to the coat in the order that they are numbered.
4. Add buckles at front and at shoulders.
5. Sew covers for tassets if required. Cut plates to fit then rivet into covers. Rivet covers to Brigandine.

BODY ARMOUR

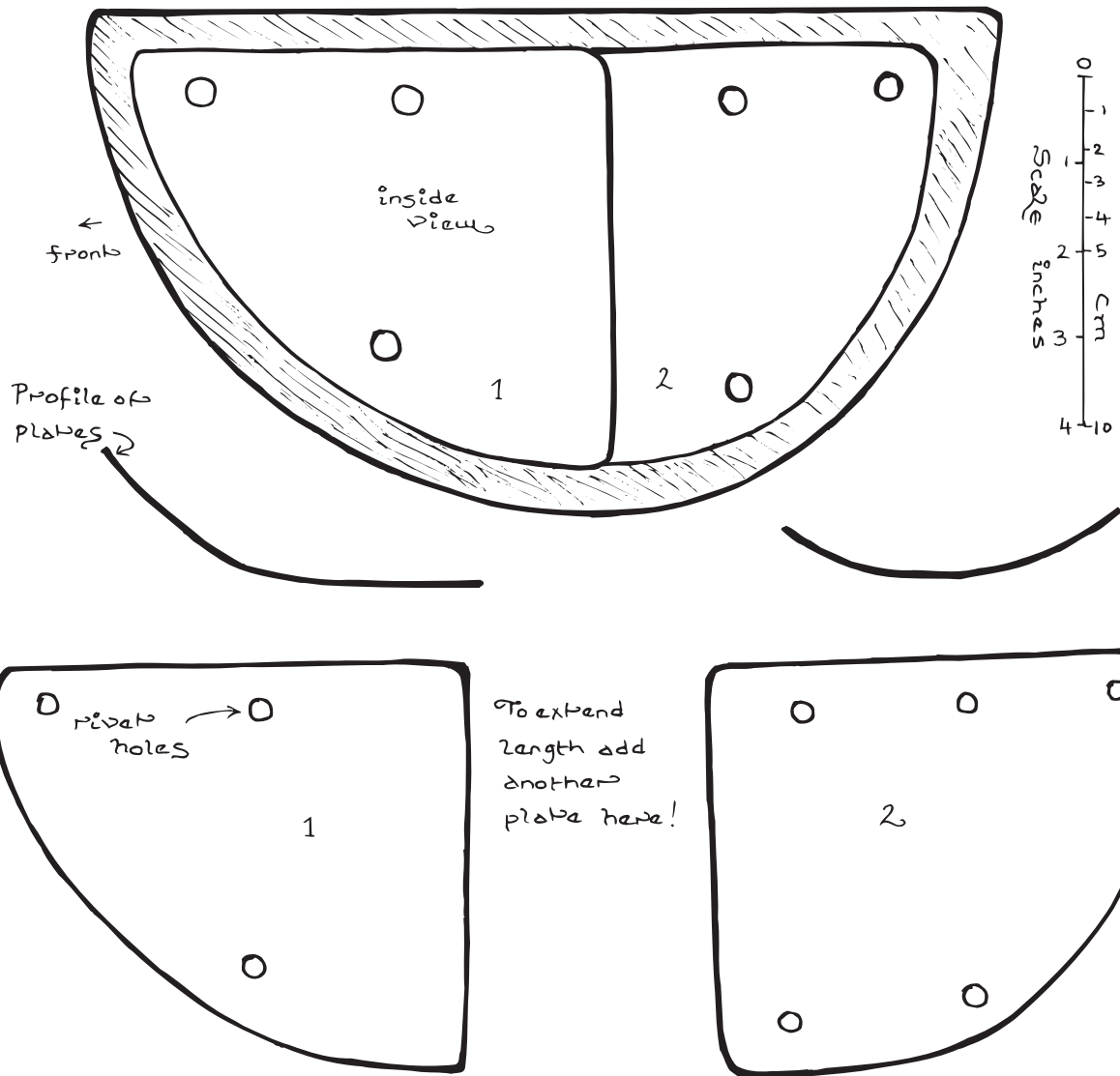

Figure 11-2: Patterns for Tassets

BODY ARMOUR

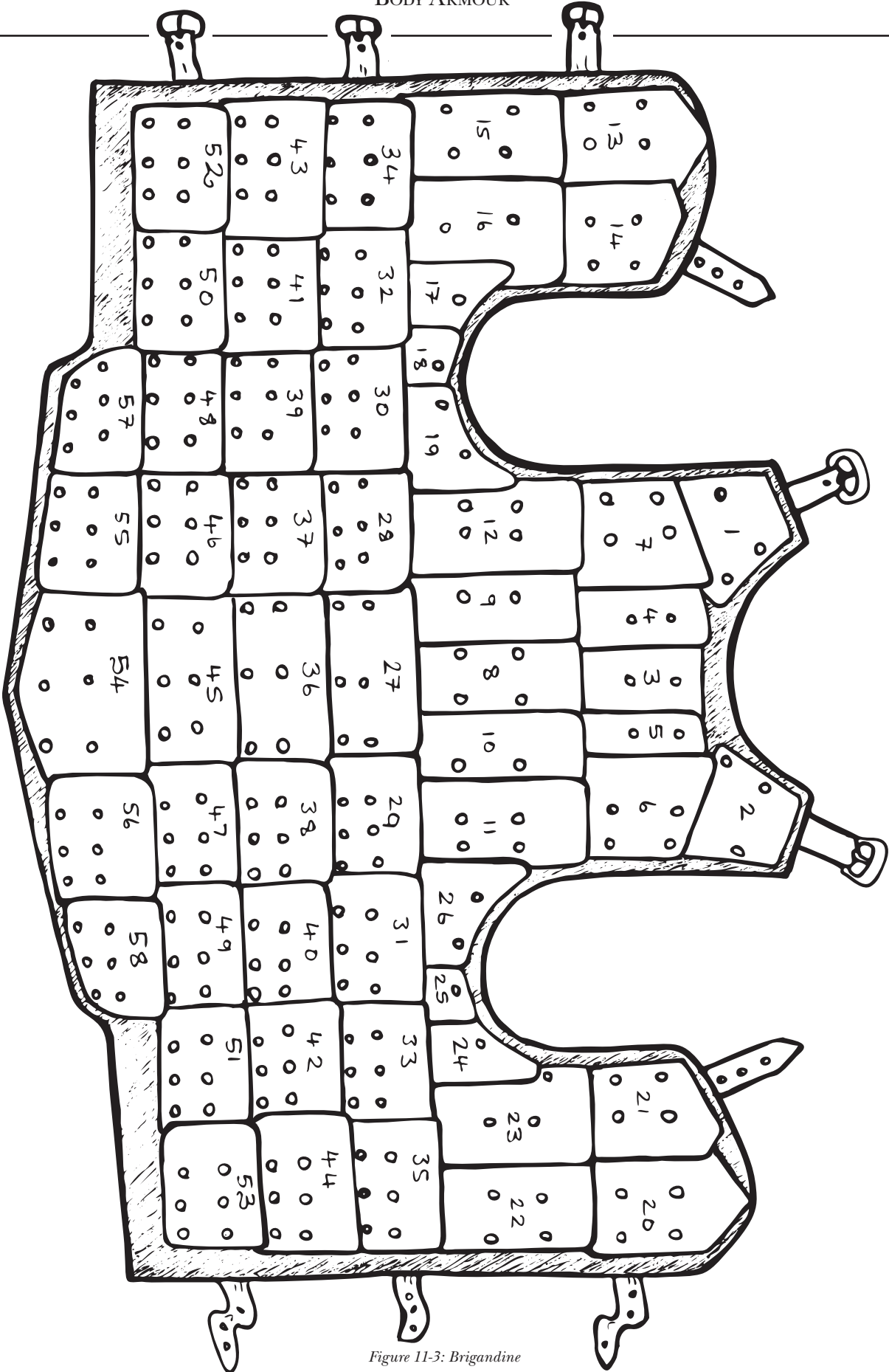
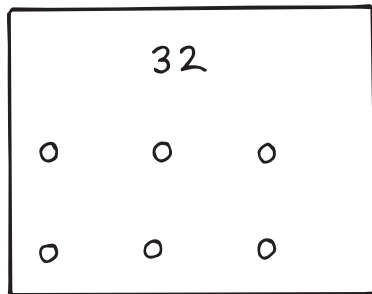
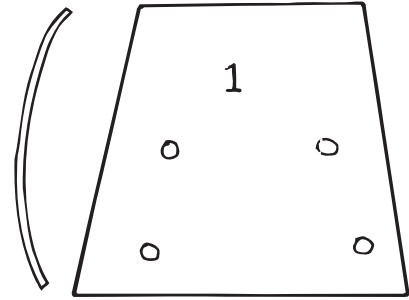
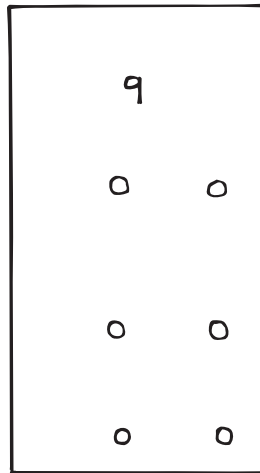
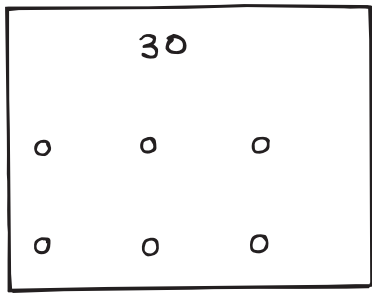

Figure 11-3: Brigandine

BODY ARMOUR



Curvature of plates as seen from the inside i.e. same view as last page.

If no profile is given for a side the it is flat!

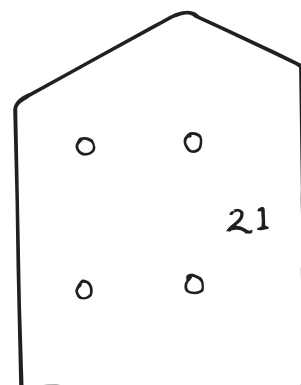
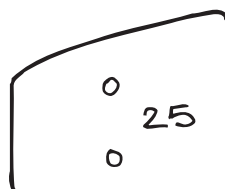
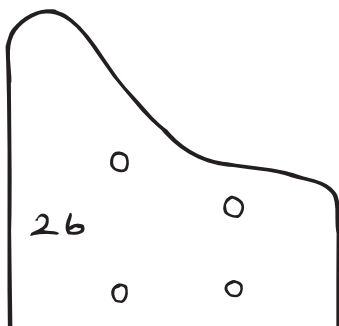
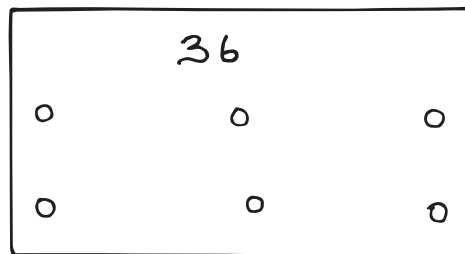
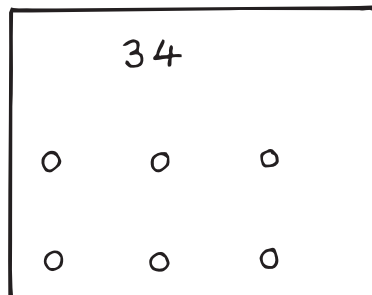
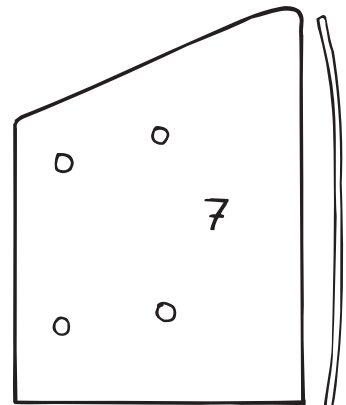
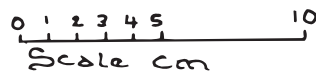

Figure 11-4: Bringandine Plates

BODY ARMOUR



Chapter 12 — Arms

Your arms move into target range every time you attack someone! Armouring them is therefore a good idea, especially if you favour two-handed weapons. When making patterns for forearms be careful to allow room for wrist rotation; a common problem is making them too long. Likewise with the upper arm allow room for the biceps; your upper arm changes shape when you flex it—if not go to the gym.

Splint Vanbrace

An early design for protecting the forearm.

1. Scale then cut the splints from steel.
2. Rivet splints onto two leather straps that both keep the plates in place and hold them on your arm.
3. Add buckles and wear.

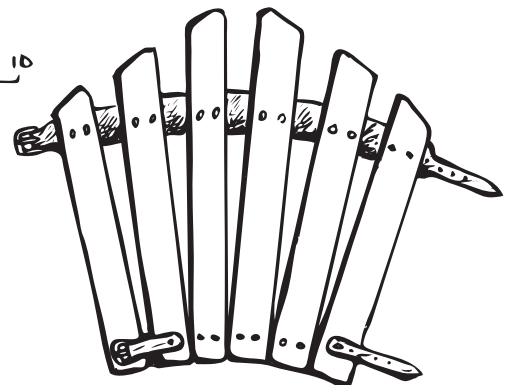
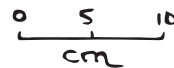

Cuir Bouilli Forearm Guard

This design protects the forearm and part of the elbow.

1. Carve a block of wood into a *former* the shape of your padded forearm.
2. Scale template to your arm then cut from a piece of thick natural tan/tooling leather. Don't make it too close fitting or you won't be able to get your arm in it after hardening!
3. Soak leather in water until it becomes malleable then stretch it around the wooden former. Hold in place with carpet pins. If you want you can now make pretty patterns all over it; look up carving in a leather working book!
4. Place into a warm oven and allow to dry slowly.
5. Remove from former. Either shave off area with pinholes, use them for decorative stitching or to stitch a lining in place. Drill holes for laces.
6. Cover with wax to waterproof.

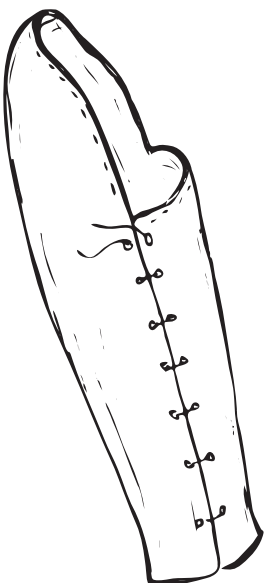

ARMS

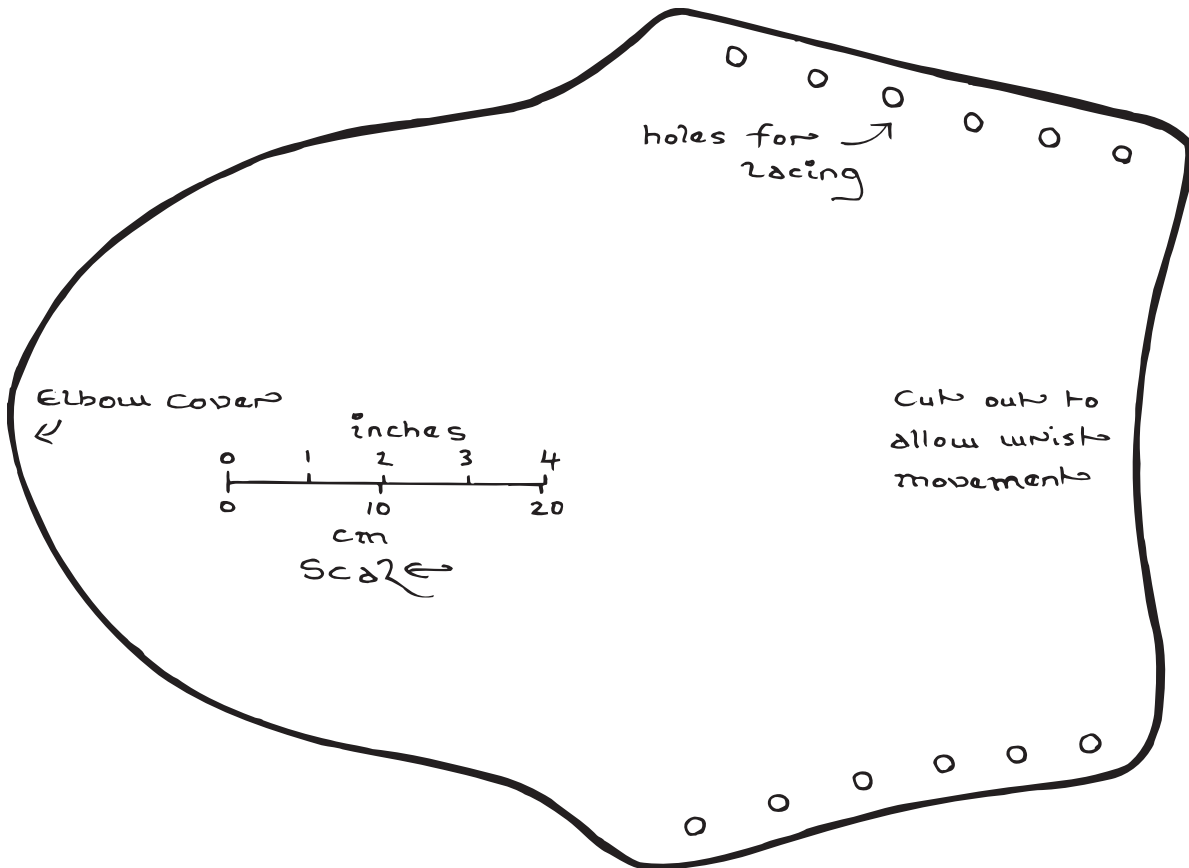

Articulated Elbow

An articulated elbow will join the forearm and upper arm protection while allowing the elbow to flex. When working out how to get articulations to work it is easier to use a separate wing (one less bit to get in the way). Once the technique is established the cop and wing can be made in one piece. After making a couple of these you will get an eye for where the articulation points should be, and all will be easy.

1. Size the elbow cop as shown then cut it out from steel.
2. If cop and wing are one piece then shape the wing part, see details later.
3. Mark the bend and centre working lines onto the inside of the cop. Note that as the cop goes further around the outside of the arm than the inside, the bend line is not in the midway between the ends.
4. Start dishing the cop around where the two working lines meet.
5. Once a reasonable depression has been produced commence hammering further out so as to curve the sides of the cop. Try to work evenly and methodically so as to give a smooth finish.

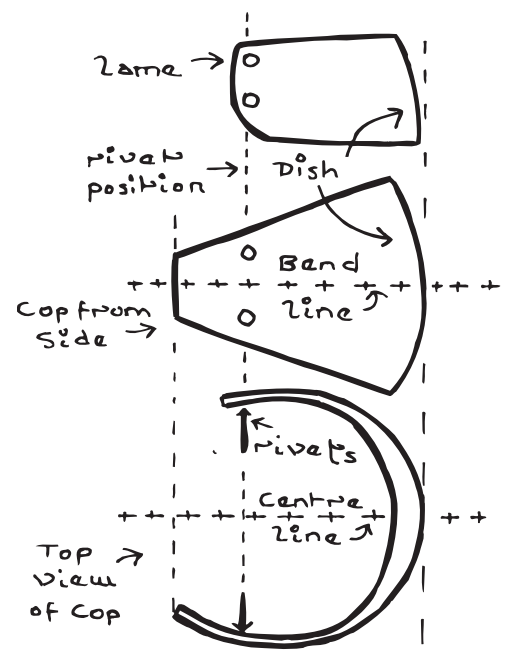

ARMS

6. Continue working, dishing the metal and bending by hand as necessary until the correct shape to fit your elbow is formed.
7. Planish the edges, and anywhere else that is a bit uneven, to give a smooth finish.
8. Drill four articulation points. Note how they are at the same height on both sides.
9. Cut two lames. If you cut them from cardboard first you will be able to adjust the size to fit your cop with ease. You will also be able to see how they articulate or where they might catch. Trying things out with cardboard first saves a lot of time. Once satisfied with the size and how they move transfer the design to steel.
10. For each lame:
 - a) Dish the lame to fit the cop.
 - b) Mark the articulation points through the holes in the cop.
 - c) Check for movement; watching your marks through the holes in the cop as you rotate the lame in and out.
 - d) Adjust until a smooth, non gaping movement is obtained.
 - e) Drill one hole, place a bolt through it, then recheck the second hole. Once satisfied drill the second and bolt in place.
11. Mate the cop with the upper and lower arm guards. Drill two holes in each lame then articulate the arm pieces to the cop in the same manner as you articulated the lames to the cops.
12. Once satisfied with the articulation replace the bolts with rivets. Don't worry if you get a lame wrong first time around; unbolt it throw it away and try again! This way you can ensure everything works before you rivet on a lame that won't fit the rest of your arm or decides to gap. If using separate wings shape then rivet in place. Depending on how well your articulation works/ fits you may need to rivet a strap across the centre to hold it in place.

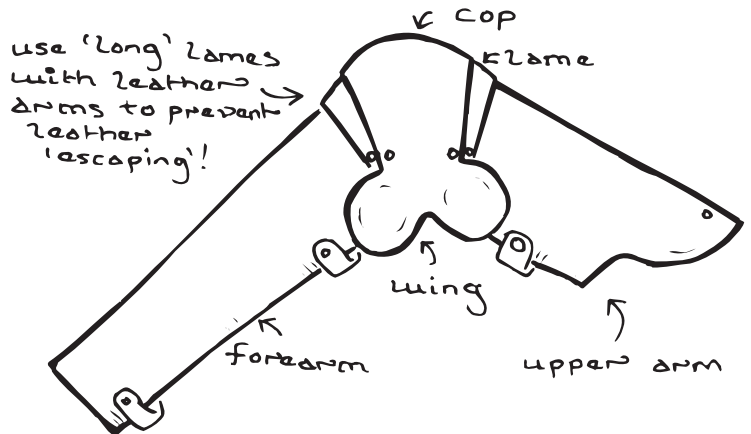

Wings

These can be made in a variety of styles, two are shown in figure 12-1. Pattern A, the twin circles, simply requires the centre of each circle to be dished inwards. For pattern B, the oval, construct a former by making two cuts into a piece of wood. Hammer the hashed area into a 'V' shaped groove thus formed. Forming a 'V' here will pull the two sides up a little; accentuate this shape slightly by hammering on the inside. Finally hammer the dotted outside area slightly downwards to produce the cross section shown.

ARMS

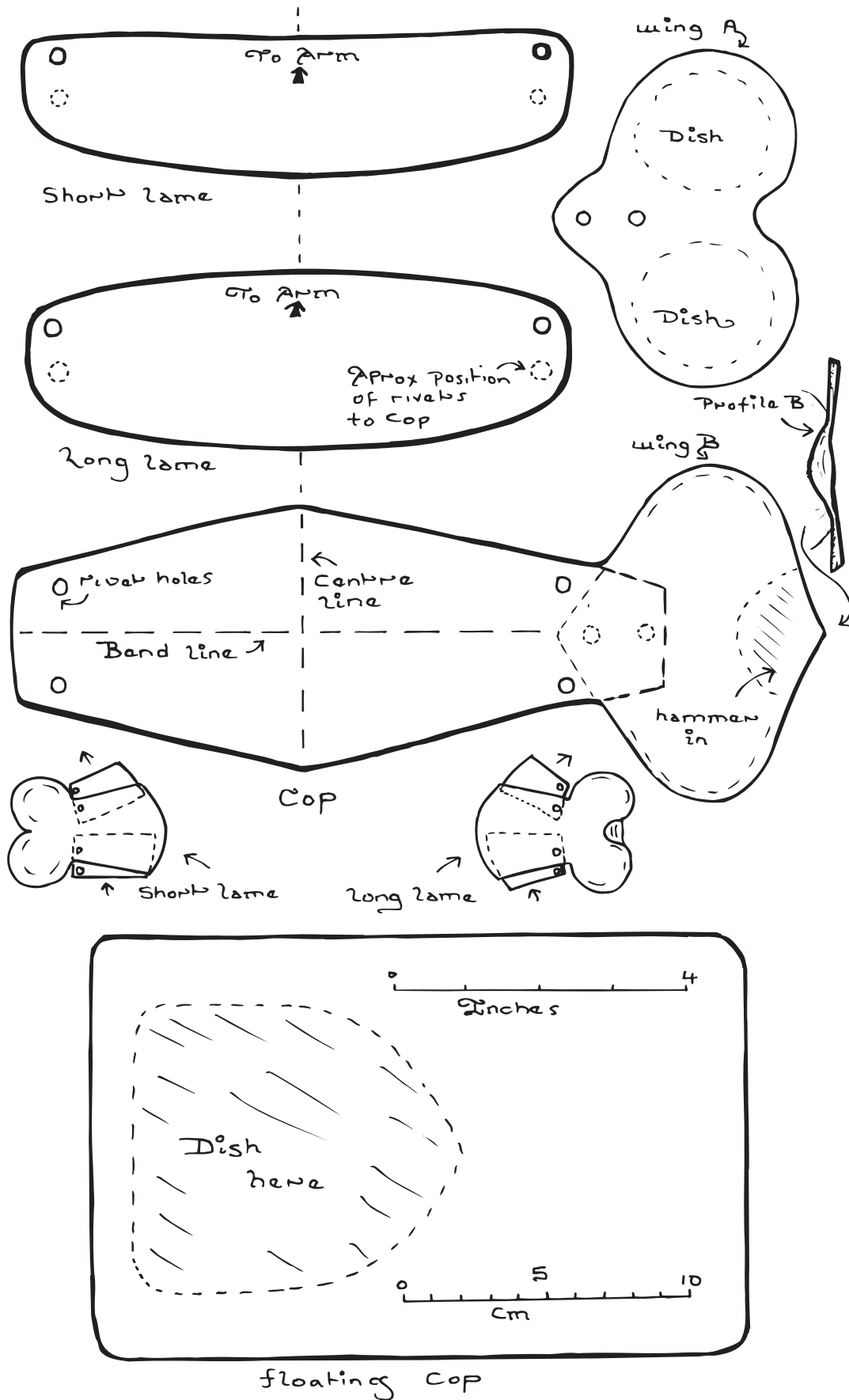
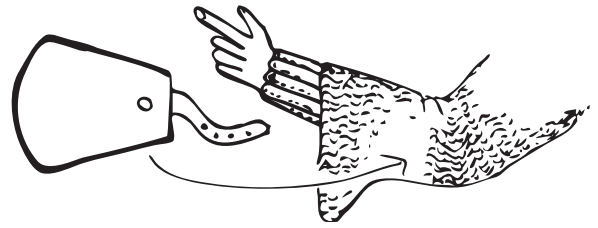

Figure 12-1: Templates for Elbows

Hidden Elbow

This is simply a metal cop that can be worn behind a shield or under clothing to protect the elbow.



It is made in an identical fashion to the articulated one above and held in place by a leather strap.

Floating Elbow Cop

This is an elbow protector that is laced to the gambeson independently of the forearm and upper arm protection.

1. Scale then cut the cop from steel (yes it is basically a rectangle).
2. Dish the hashed area of cop to fit elbow; it needs to be dished more in the centre than the edges.
3. Continue dishing until a curved cop shape is formed. As you work the outer edges will be forced out to form *wings*. Accentuate this shape by planishing them on a stake. Try to get a crisp fold edge between the dished part and the outer wings.
4. Roll the edges of the wings to strengthen the cop.
5. Drill lacing holes, two sets in the outer side and one in the inner.
6. Hold in place, on gambeson, with three sets of points.

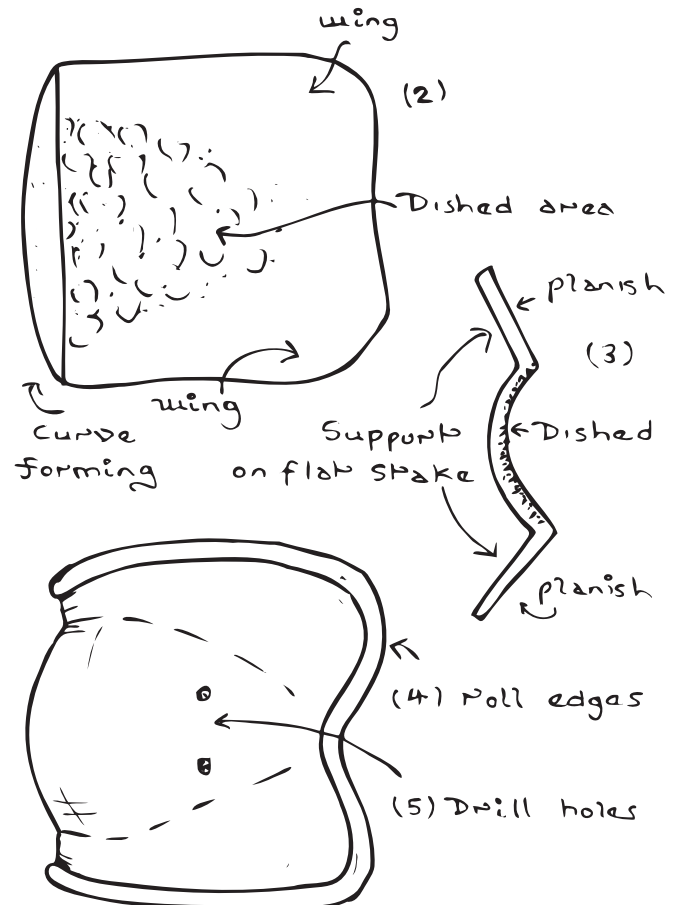

Splinted Upper and Lower Arm Guards.

These are made of leather reinforced with steel strips. The two pieces are held together by an articulated elbow or pointed individually to the arm under a floating cop. They give good lightweight protection.

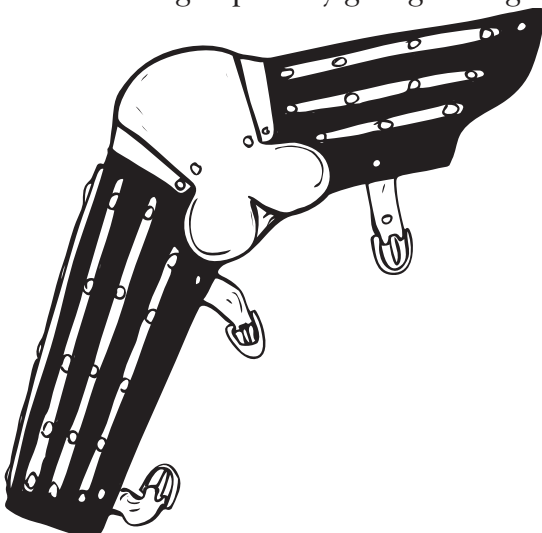

1. Scale patterns to fit arm then cut from heavy weight leather.
2. Work out attachment points for straps and points. The straps should hold it to your arm without restricting movement; the upper part laces to your gambeson so the holes in it should line up with your arming points.
3. Cut strips of steel for splints. Failing that buy the metal in a strip then cut to size; stainless steel strip, for example, is used

Patterns for Splinted Arm Guards

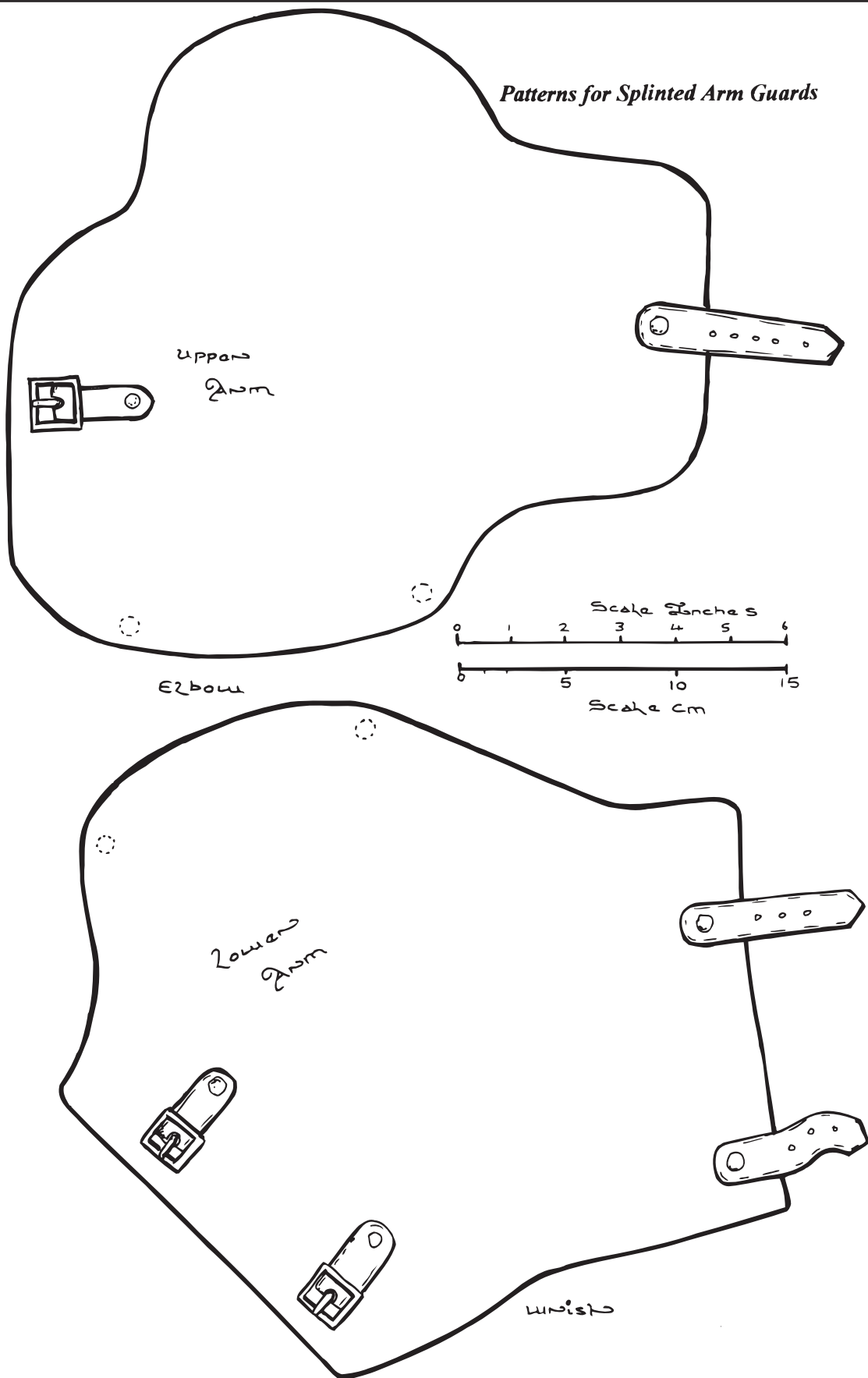

Figure 12-2: Patterns for Splinted Arm Guards

ARMS

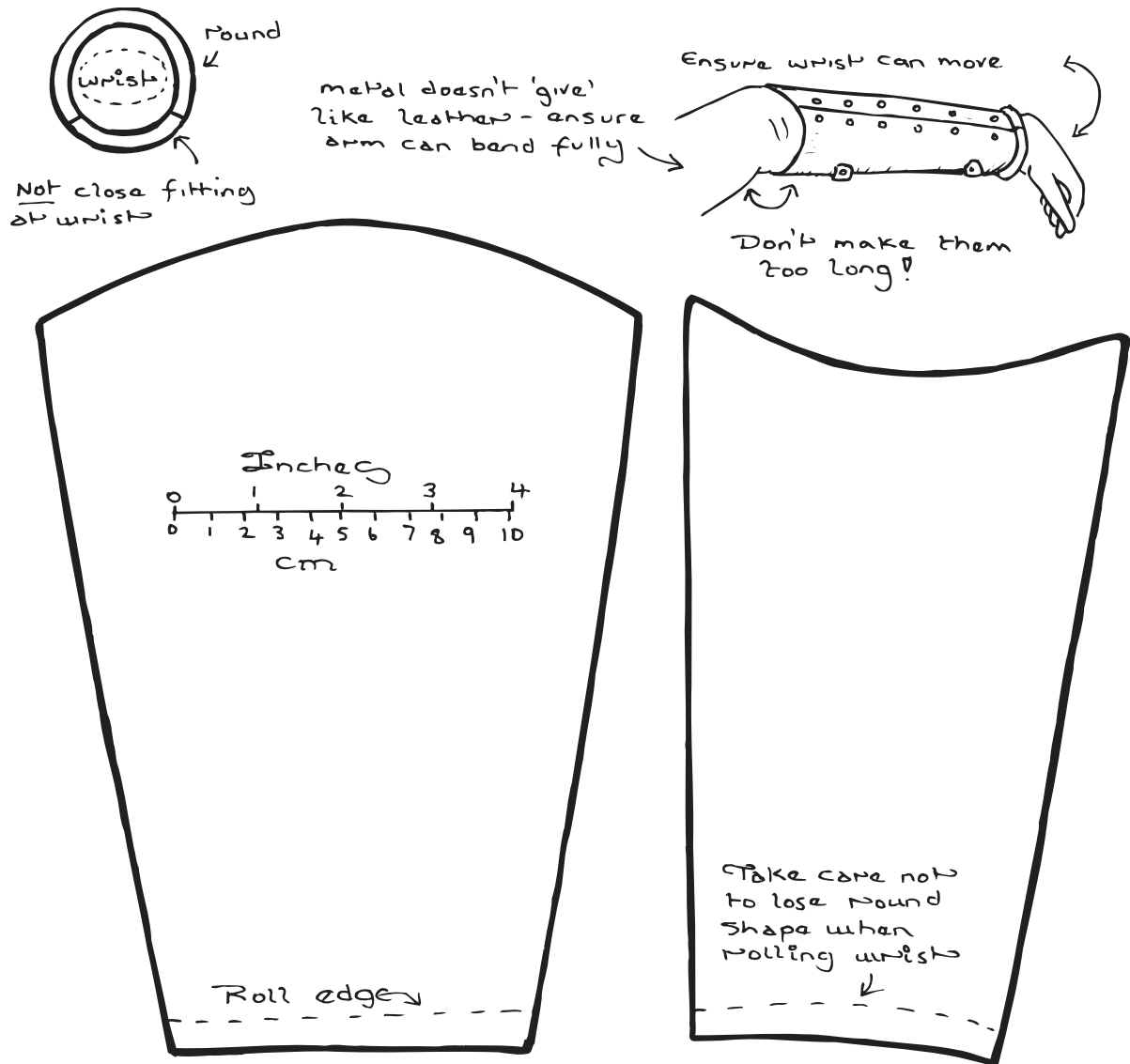

Figure 12-3: Patterns for Plate Arm Guards

ARMS

as box packaging. Remember to allow space for your elbow protection.

4. Drill holes for rivets—it's easier to do strap and strip holes at the same time—then rivet strips and straps in place
5. Rivet to elbow and/or lace to points on gamberson.

Plate Arms

Full plate arms offer excellent protection but are rather heavy and prone to taking dents! Cuir Bouilli arms can be constructed to similar patterns (no edge roll). They work in the same way as the splinted arms above but, because the material they are made of is less flexible, they require a hinged opening to fit around your arm.

1. Scale patterns to arm then cut from steel. Allow for edge roll at cuff but ensure wrist can still move.
2. Curve plates to fit arm.
3. Roll wrist edge on both halves of forearm plates. File edges to ensure both halves fit together well.
4. Make and fit hinges; these are simply a piece of leather riveted to the back of the plates or you could make a metal hinge as per the Copergate helm design if you prefer.
5. Add closure straps and buckles.
6. Rivet to elbow or lace to points on gamberson.

If you want something lighter, whilst giving equivalent protection, you could substitute thermoplastic for the steel. Leave off the edge roll and then cover in thin leather or fabric before adding the closure straps.

Upper Sleeve

This forms an extra protection for the upper part of the arm and the shoulder.

Padded

1. Make three layers, a tough outer one, an inner one of quilted padding and a liner.
2. Sew them together then attach to shoulder with points.

Brigandine

1. Make cloth outer as shown.
2. Line with small plates.
3. Attach to shoulder with points.

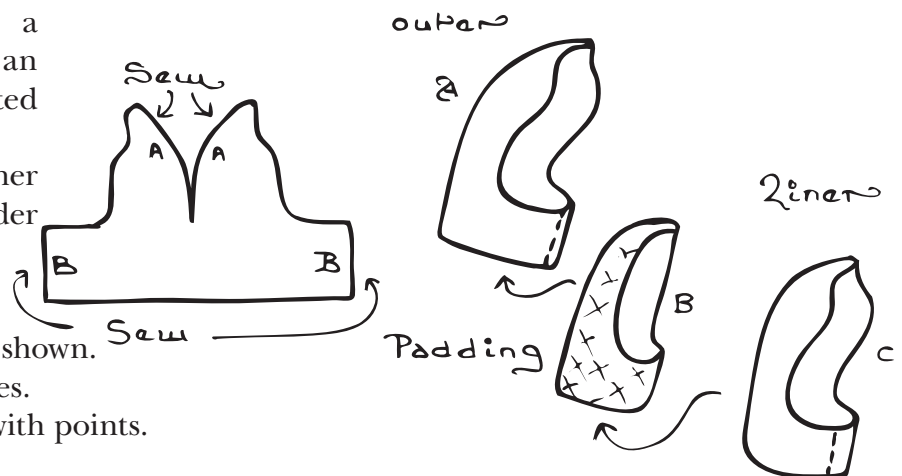

Shoulder Guard

This design works equally well with steel, Cuir Bouilli or thermoplastic. The description below uses steel; adapt as necessary. Shoulder guards can either be laced to the gambeson or strapped to the body armour or neck guard.

1. Scale patterns to fit then cut from steel.
2. Bend plates to fit your arm. The top plate needs to be lightly dished to fit the shoulder.
3. Drill holes as shown then rivet leather straps in place to allow plates to articulate. The bottom plates are joined with two straps. They join to the shoulder plate with a single strap.
4. Rivet buckle strap in place to hold shoulder guard to upper arm.

Shoulder With Sliding Rivets

A later period design using sliding rivets (see Chapter 7) to provide the necessary articulation. Remember the holes need to be one drill size larger than the rivets and the slots need to be the same width as the holes.

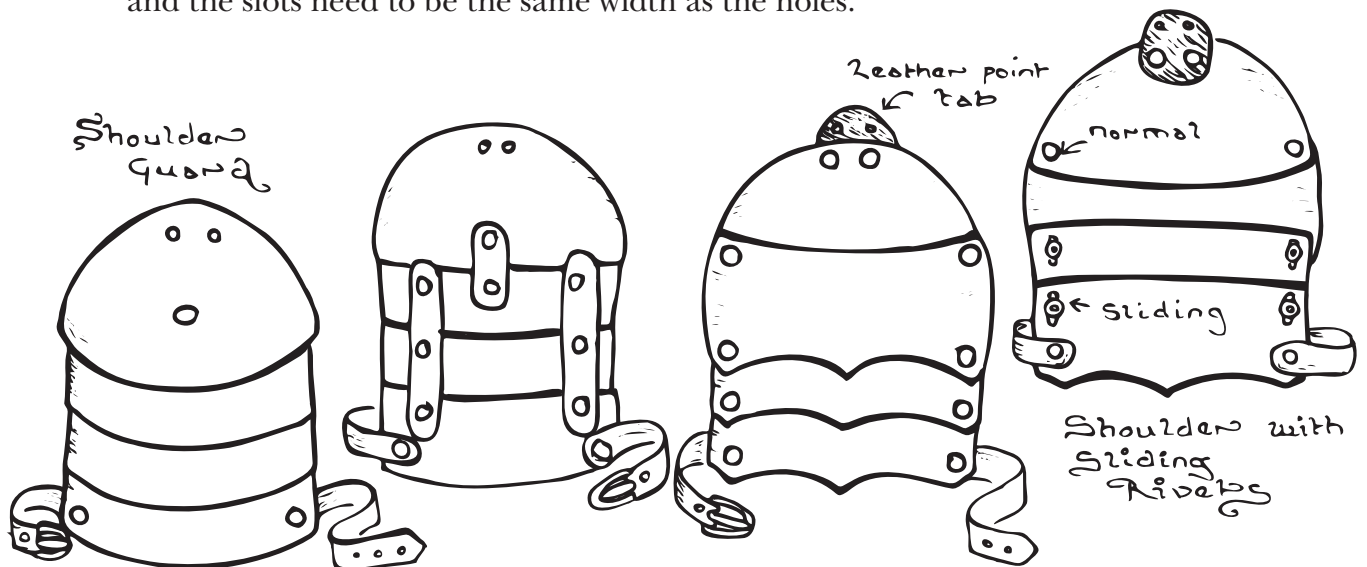

1. Scale patterns to fit then cut from steel.
2. Bend plates to fit your arm. Plate 1 needs to be lightly dished to fit the shoulder.
3. Note how the plates go together; plate 2 goes over plates one and three. Plate 4 goes under plate 3. Next note the position of the sliding rivets; the *slots* for articulation are cut in the covered plate. Drilling a hole then filing makes the slots, to give the correct amount of articulation. If you simply bolt the plates together you will be able to check the articulation as you go.
4. Once you are satisfied with the fit/movement rivet everything together.
5. Drill holes as shown in lower plate then rivet straps in place.

ARMS

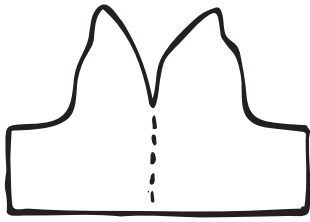

fold material
then cut to
give shapes
above

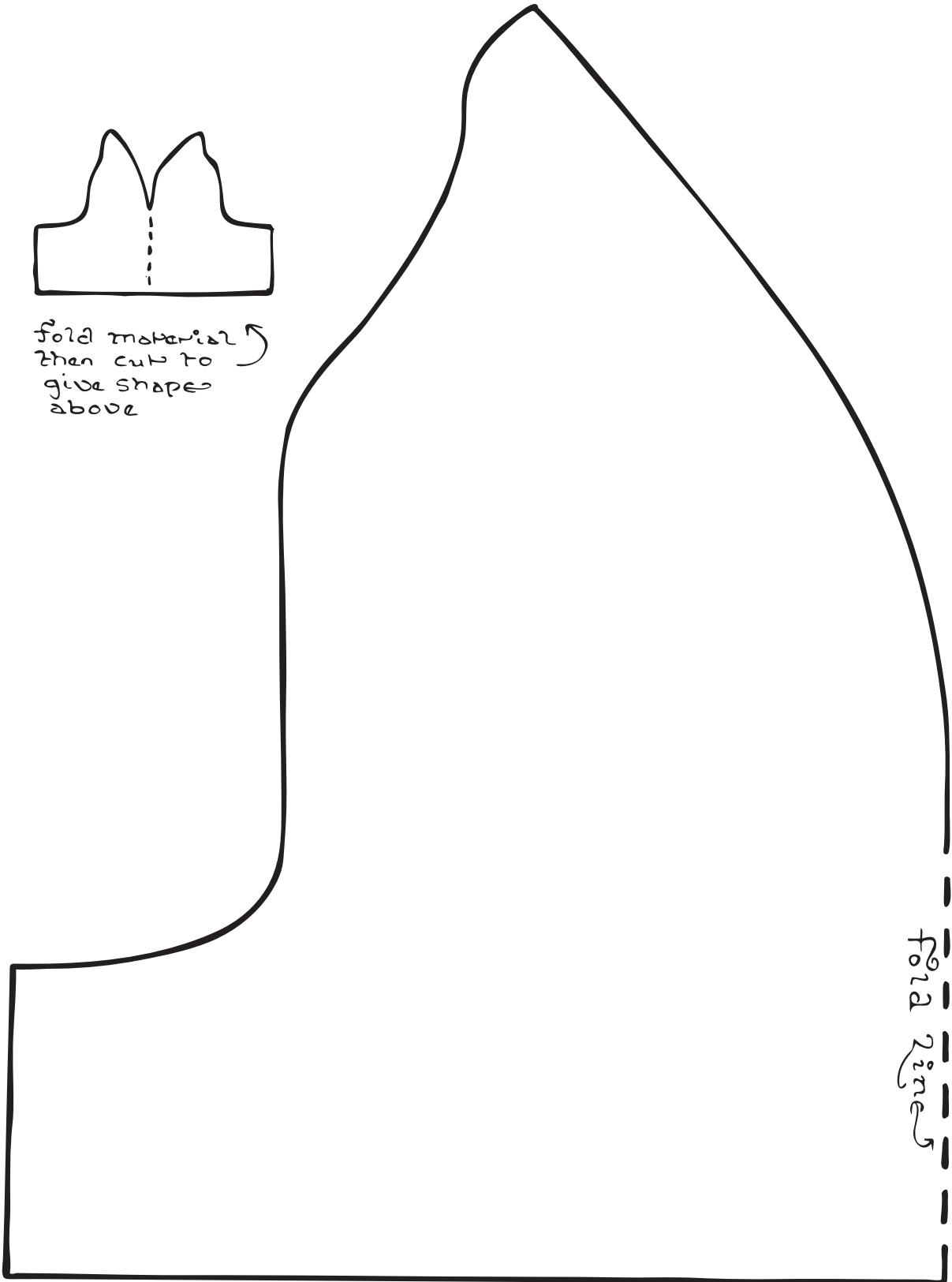

fold line

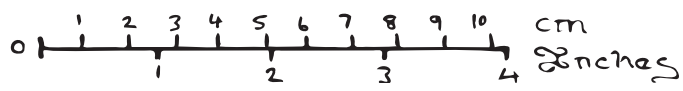

Figure 12-4: Upper Sleeve

ARMS

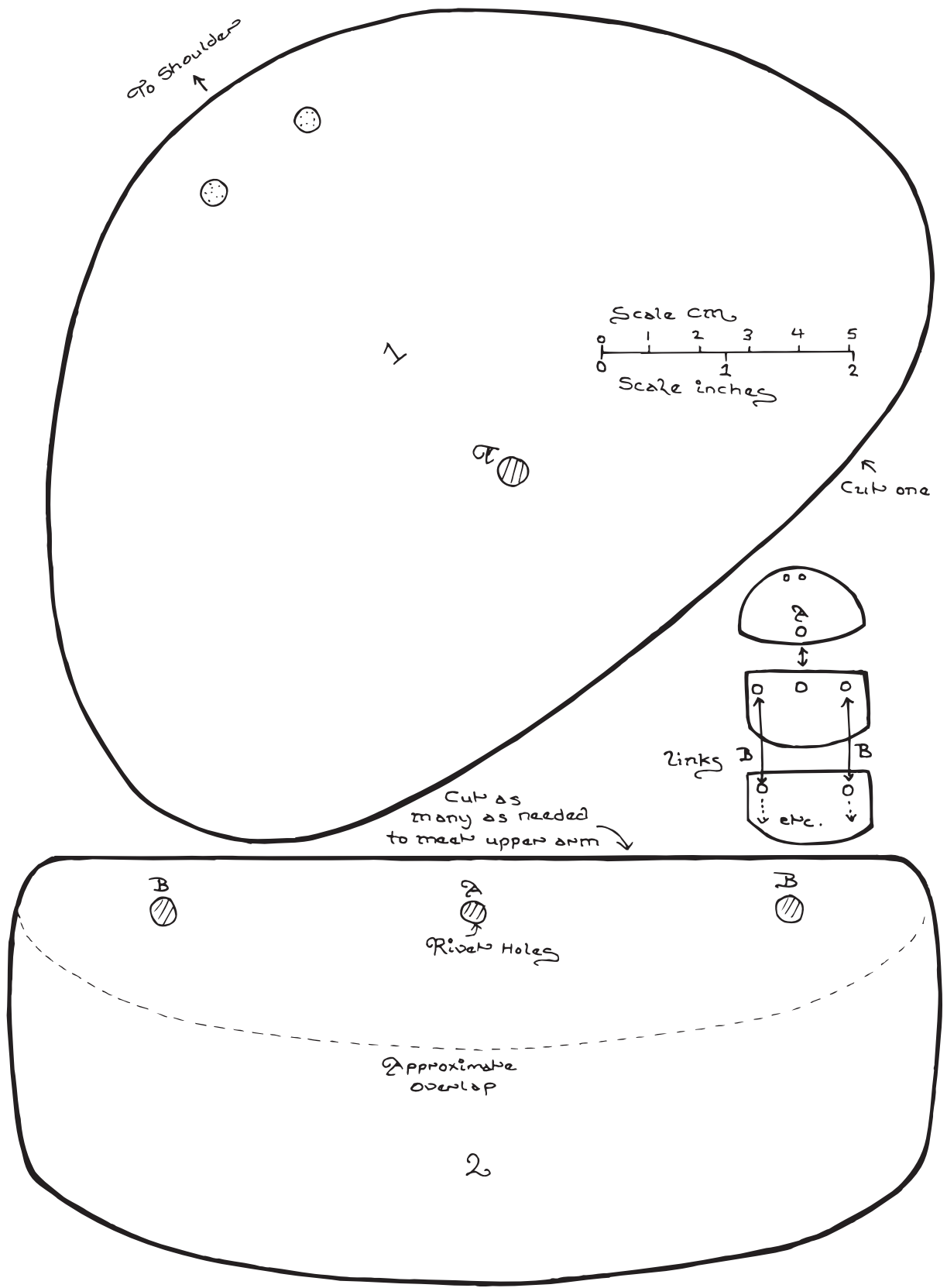

Figure 12-5: Shoulder Guard

ARMS

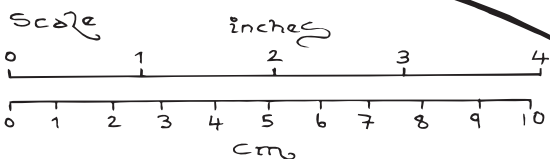
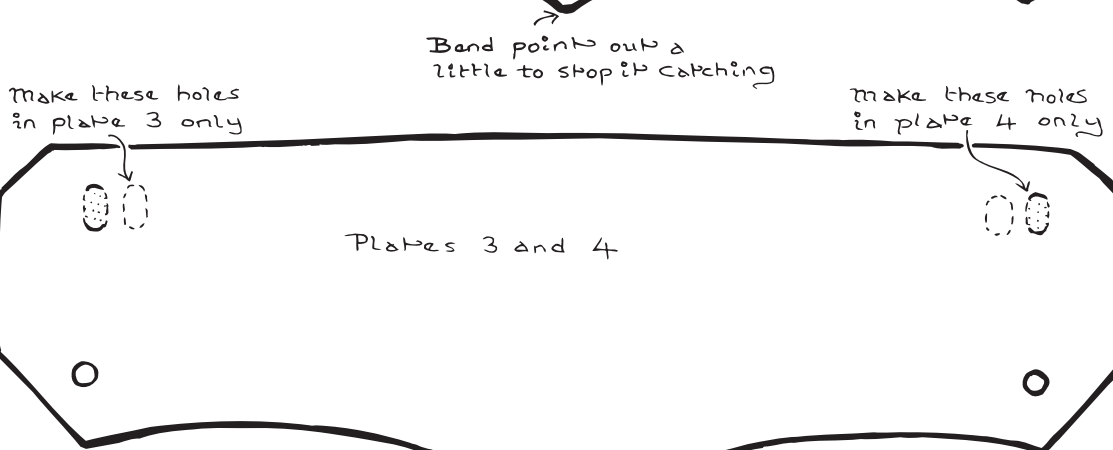
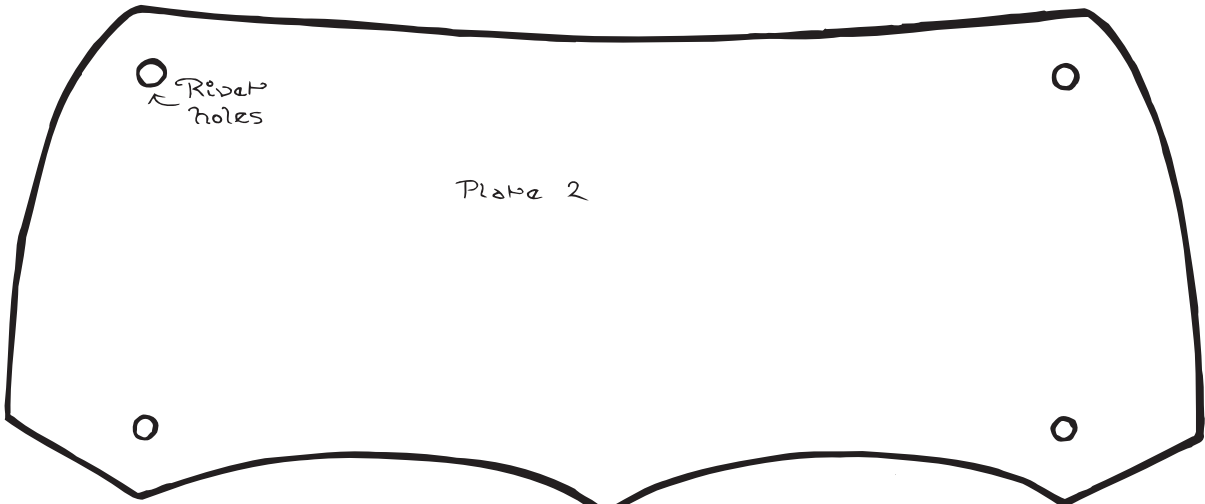
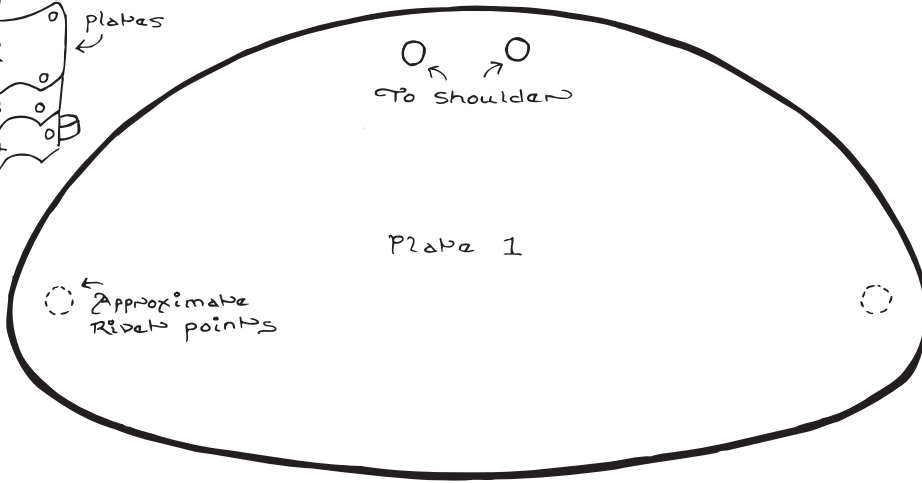
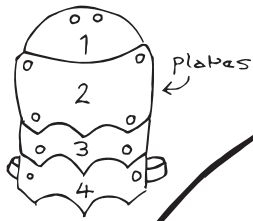
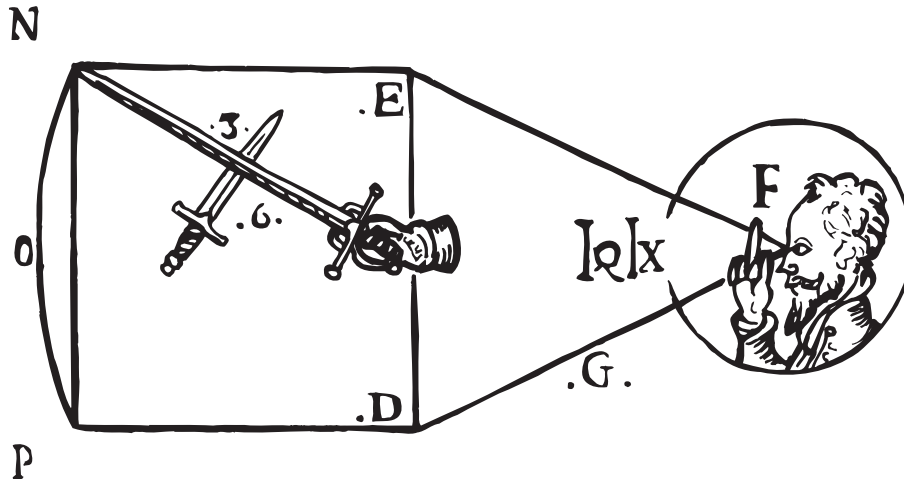

Figure 12-6: Shoulder with sliding rivets



Chapter 13 — Hands

Your hands are delicate and vulnerable to impact during combat; it therefore makes sense to protect them! To be fully effective the protection should cover the thumb, fingertips, fingers, back and side of hand, thumb and wrist. If the edges of the gauntlet are in contact with the weapon then the force of any blow striking the hand will be spread onto the weapon rather than the hand itself—this is a good thing!

Wisby Fingert Gauntlet

This is based upon 14th century remains unearthed in Gotland. The cuff, which is missing on the original, is my own design. The entire gauntlet consists of 29 plates, which are riveted onto the outside of a leather glove. In fact the most difficult part of the construction is making the padded glove! If you are lucky enough to have small hands then find two pairs of gloves that fit inside each other. Build the gauntlets on the larger, outer pair and use the inner pair to adsorb the impact of any blow that strikes home. If however, you have large hands you will either have to attach a layer of leather to the top of an existing glove or else sew a large outer glove.

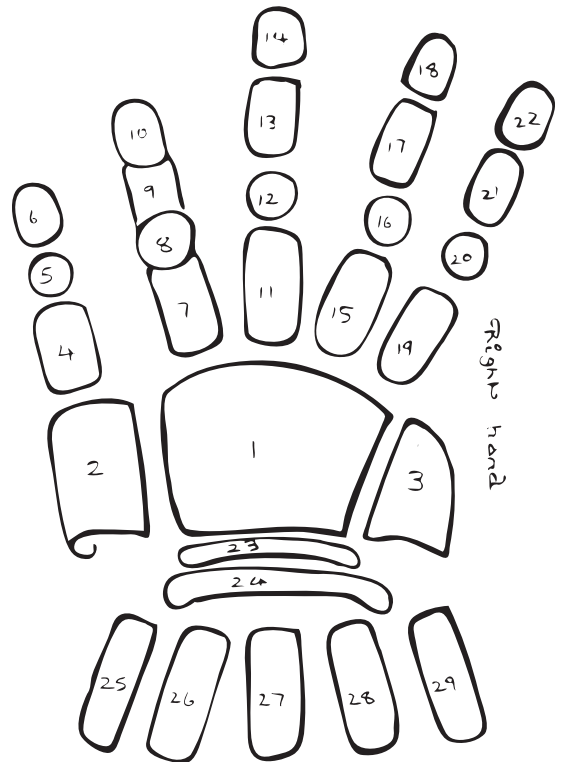

Assembling the gauntlet is very simple.

1. Mark out all the bits, bar the knuckle plates onto your steel and cut them out.
2. Mark, dish, then cut out the knuckles.
3. Bend everything to shape and raise the finger tip plates over at the ends
4. Rivet everything together.

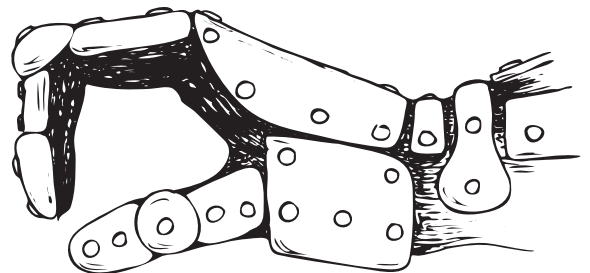

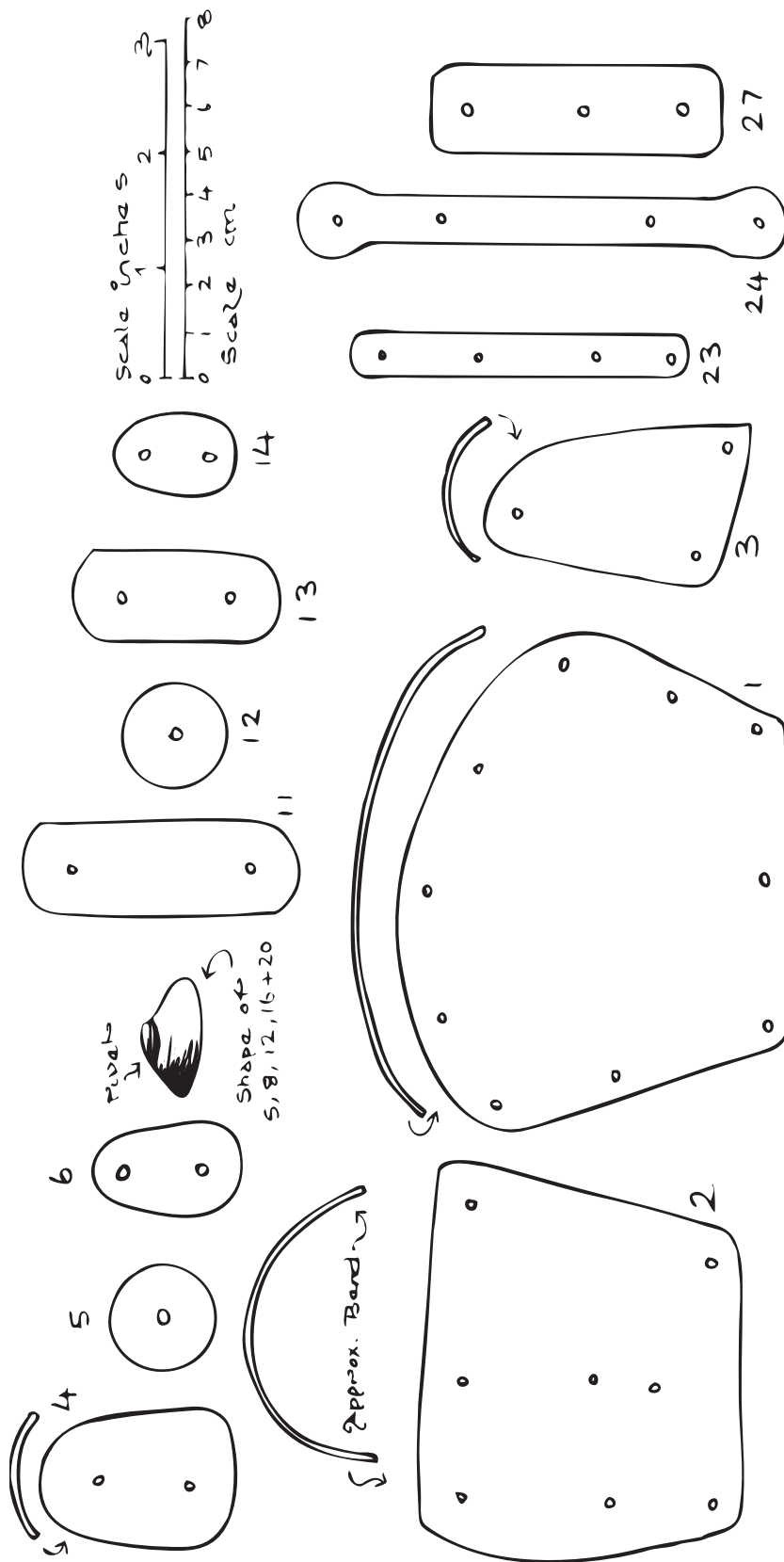
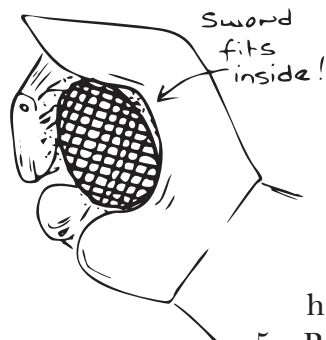
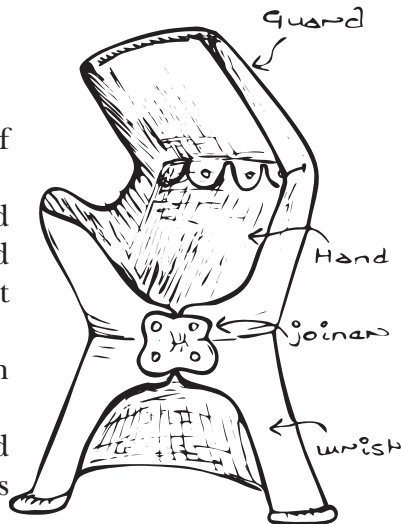

Figure 13-1: Patterns for Wisby Fingered Gauntlets

Hourglass Gauntlet

A design in which the folded and raised edges impart a lot of strength.

1. Cut out the templates for the three main pieces and adjust to fit your hand. Check that, with glove on and padding in place, your hand can fit through the wrist hole and that the gauntlet fits your sword.
2. When satisfied with the fit, cut the various pieces from steel.



3. Roll the hand plate into an oblong-based cone (as shown on the diagram in figures 13-2 to 13-4).
4. For the next piece you will need a former with a V notch in it. Place the plate over this and hammer down the area shown. This should then match the shape of the

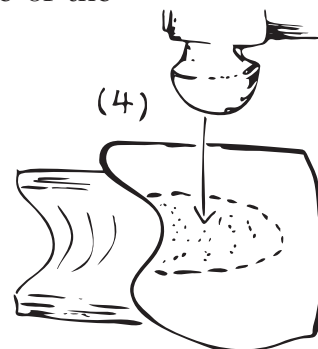
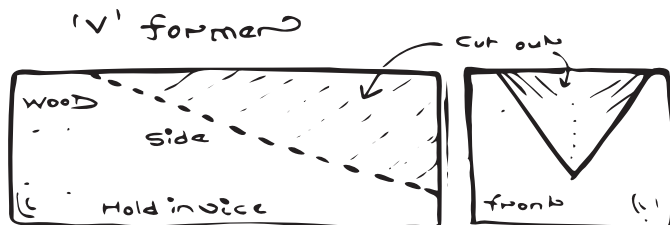

5. Roll the wrist plate, again into an oblong cone, and then raise the bottom out to match the base of the hand plate. This is fairly tricky and must be done correctly or else the gauntlet will not have its full strength. Check the shape of the two plates in relation to each other and your hand. Remember that you must be able to get your hand into the gauntlet! If the opening is now too small bend the plates out into larger ovals and use a bigger joining plate. You will find a little dishing around the base of the thumb helps the gauntlet go on.

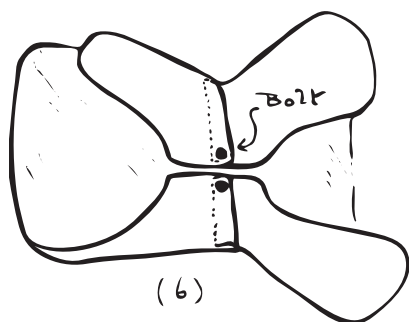
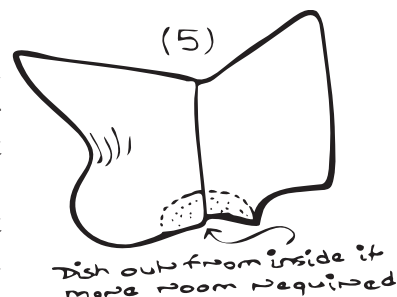
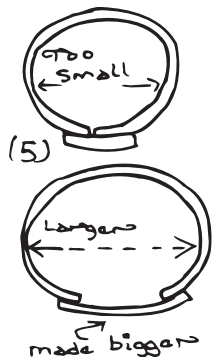

6. Temporarily bolt the two plates together. Then shape the joiner piece (which is fun as it bends in every conceivable direction at once!). Finally rivet the three pieces together.
7. Roll the cuff of the wrist plate.

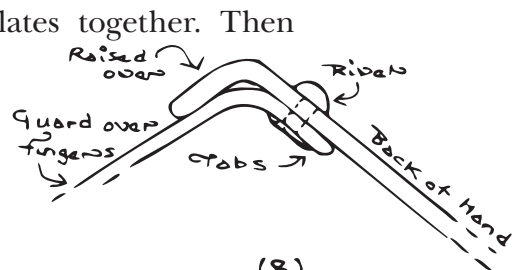

8. Shape the guard plate and then raise the end of the hand plate to match it. Rivet the guard plate in position and then roll the end of it to provide extra strength.

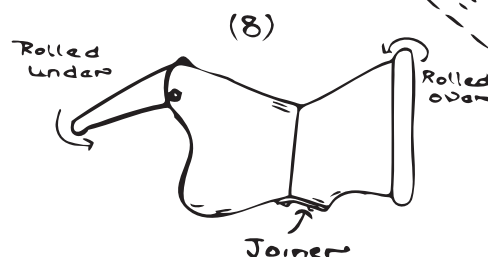

9. Now cut the fingerplates. There are two per finger and another two for the thumb. The plate size will, of course, vary from finger to finger; the sizes shown are just a guide.
10. Curve the plates to fit the fingers, raise the back of the fingertip plate to give the shape shown above, and then drill the rivet holes. Next cut a piece of leather to go over the top of each finger and line the inside of the fingerplates with felt (or other padding).

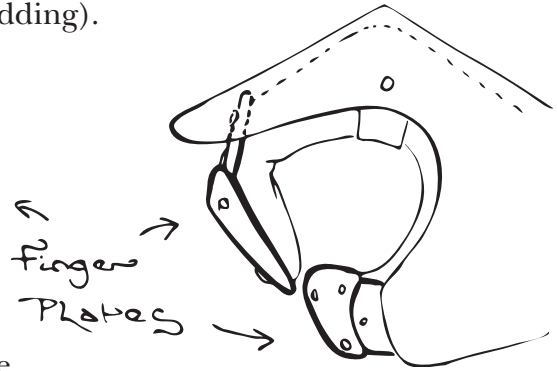
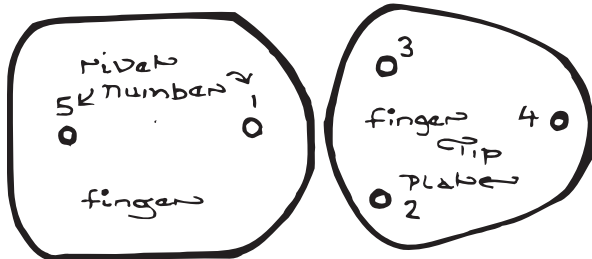
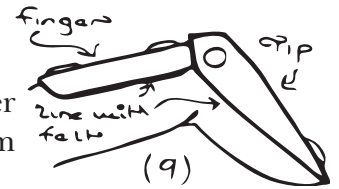

11. Rivet the plates to the leather and glove as illustrated.

The rivets are fitted as follows:

- (1) Finger plate to leather strip next to overlap of plates
- (2)&(3) Tip plate to leather strip at joint
- (4) Finger tip through leather strip to end of glove
- (5) Finger Plate through leather to glove.

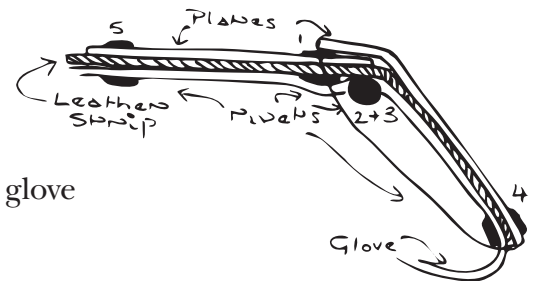

Simple Gauntlet

This is a design that gives good mobility and protection without being too hard to construct.

The main trick is to build the gauntlets to fit the hand in the closed position; that is when holding onto a weapon. The articulations then allow the hand to open. As you are unlikely to be fighting with your hand open, any gaps or bad coverage in this position will have little effect. Also take note how your hand curves around when it closes. Because your fingers joints are of different lengths it doesn't fold neatly into a cylinder when you clench it! You have to allow for this slight 'conical' movement to get the gauntlet to articulate with your hand. Also note your range of wrist motions; your gauntlet should not impede these! Small (1/8 inch) rivets work well for gauntlets. It's a good idea to bolt everything together until you complete a gauntlet then try out the range of movements before you rivet. In this way you can adjust the movements without having to drill out rivets. You may find the following adjustments useful:

- a) If things won't line up try turning the hole into a slot or oval, preferably on the inner plate, with a file; turning it into a sliding rivet.
- b) If you get big gaps try re-bending the plate or remaking it with the holes in a slightly different place; otherwise known as learn-

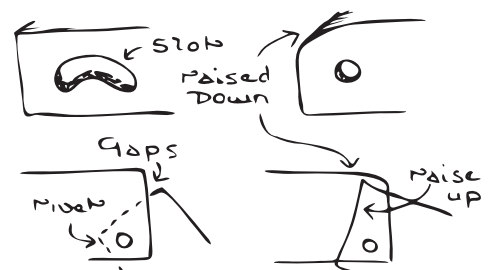

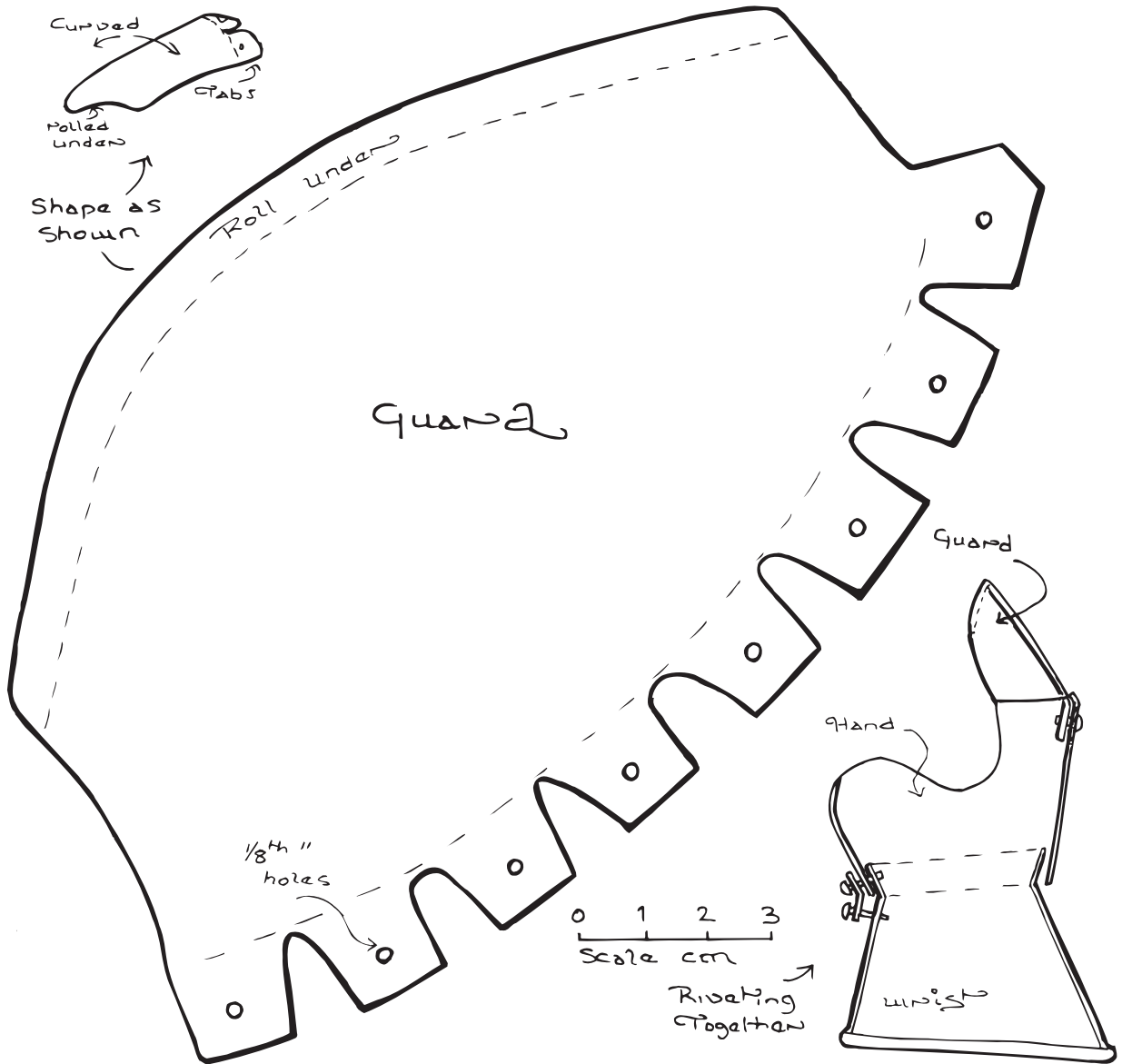

Figure 13-2: Patterns for Howglass Gauntlet

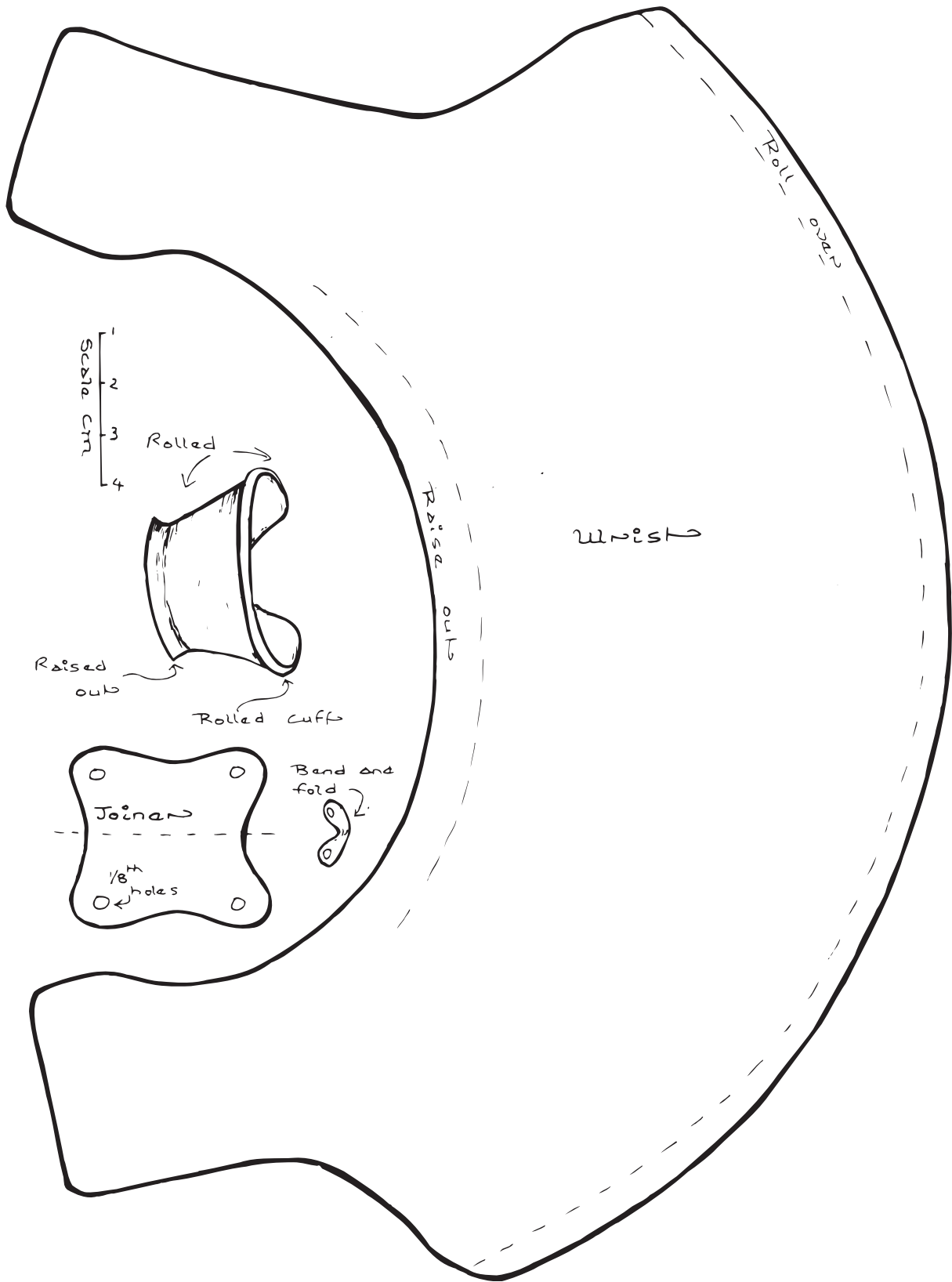

Figure 13-3: Patterns for Hourglass Gauntlets (cont.)

HANDS

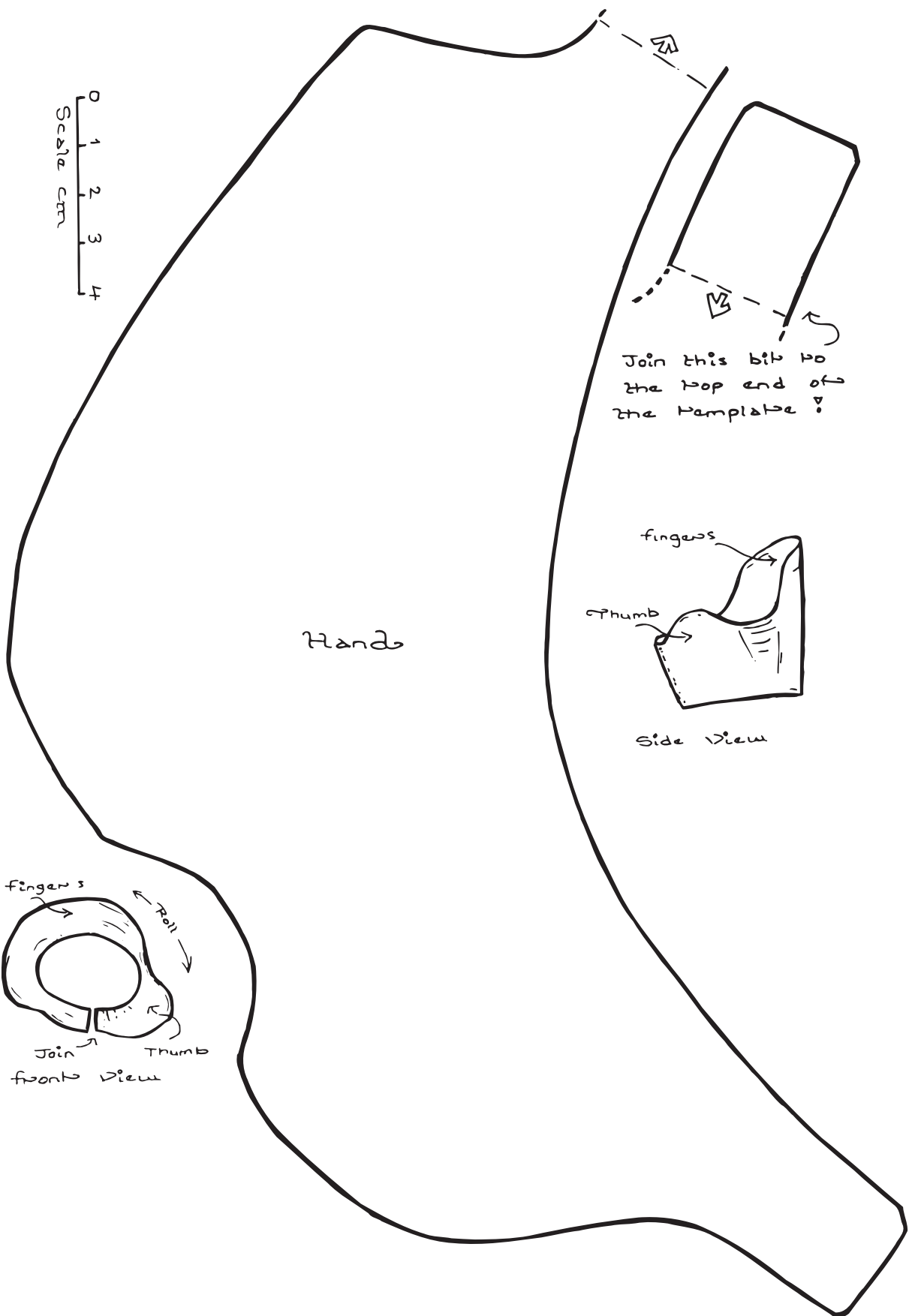
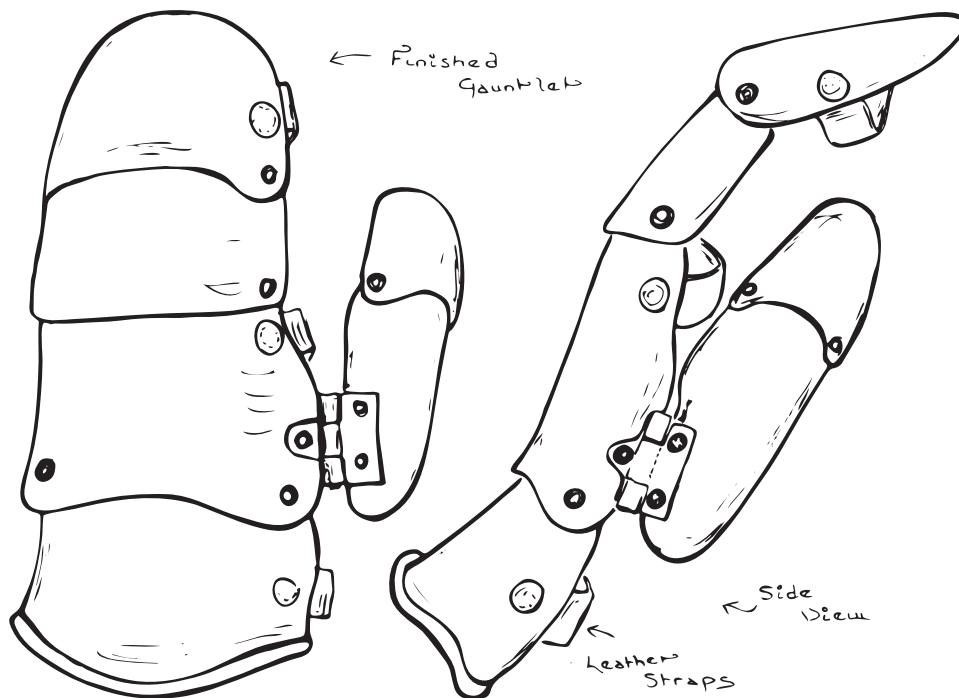

Figure 13-4: Patterns for Hourglass Gauntlets (cont.)

HANDS

ing from experience! Hey steel is cheap—why waste time on something that obviously isn't going to work?

- c) If you get small gaps try raising the edge of the inner plate up or the edge of the outer plate down or both until they catch.



1. Adjust templates remembering to allow for padding inside the gauntlet and noting that both your hands may not be the same size! A cross section of the final shape of each plate, between the marked points, is shown on each template. Dotted lines show where the majority of the bending occurs. The best way to do this is make rough patterns and adjust as you go; the fitting of one plate may change the shape of the next!
2. Cut out then shape the back of hand plate. This curves around the hand meeting the weapon on one side and bending slightly upwards on the other to allow the thumb to move.
3. Shape the wrist plate. This fits inside the previous plate and should articulate to give full wrist movement; the rough articulation points are shown on the templates. Roll the back edge to strengthen it.
4. Shape the fingerplate and the fingertip plate and then persuade these to articulate.
5. Shape the two plates that go over the thumb. The thumb tip plate needs raising down to provide full protection; it goes on top of the base of thumb plate. The thumb is held to the rest of the gauntlet by a small (about 25 mm) hinge which can be purpose made or else cut down from a commercial one as shown. It is attached with two rivets to the thumb and one to the hand plate thereby allowing it to act as both a hinge and a swivel.
6. Once happy with the fit rivet everything together then pad the inside. Leave spaces where the plates overlap bare or the padding will prevent them moving! Add leather straps to hold the gauntlet onto your hand as shown.

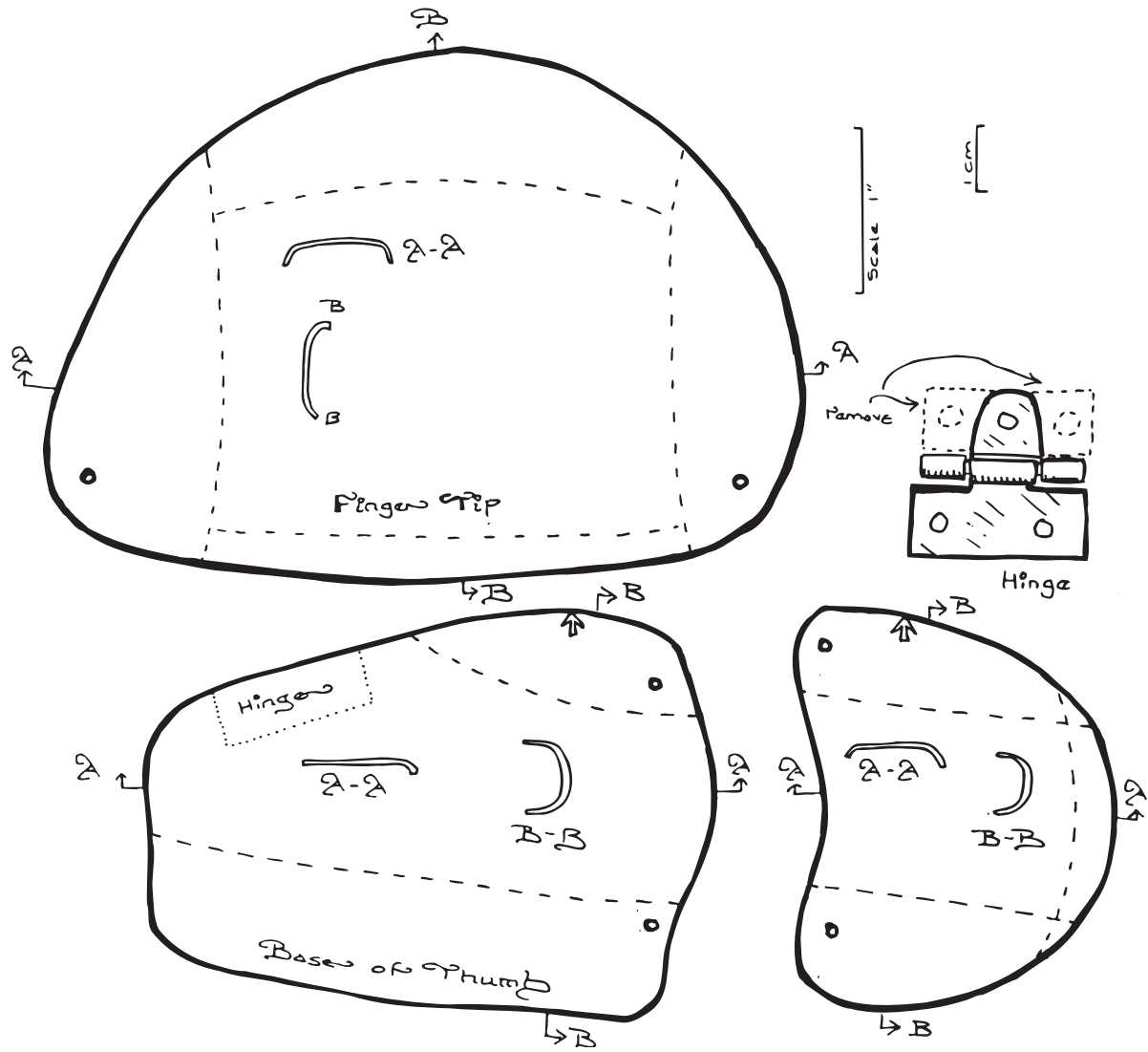

Figure 13-5: Patterns for Simple Gauntlets

HANDS

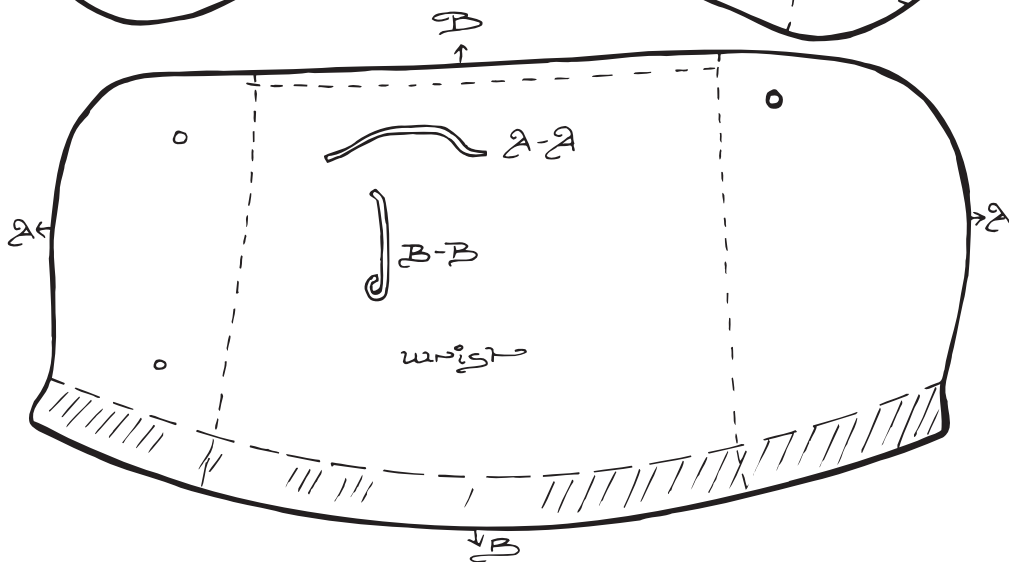
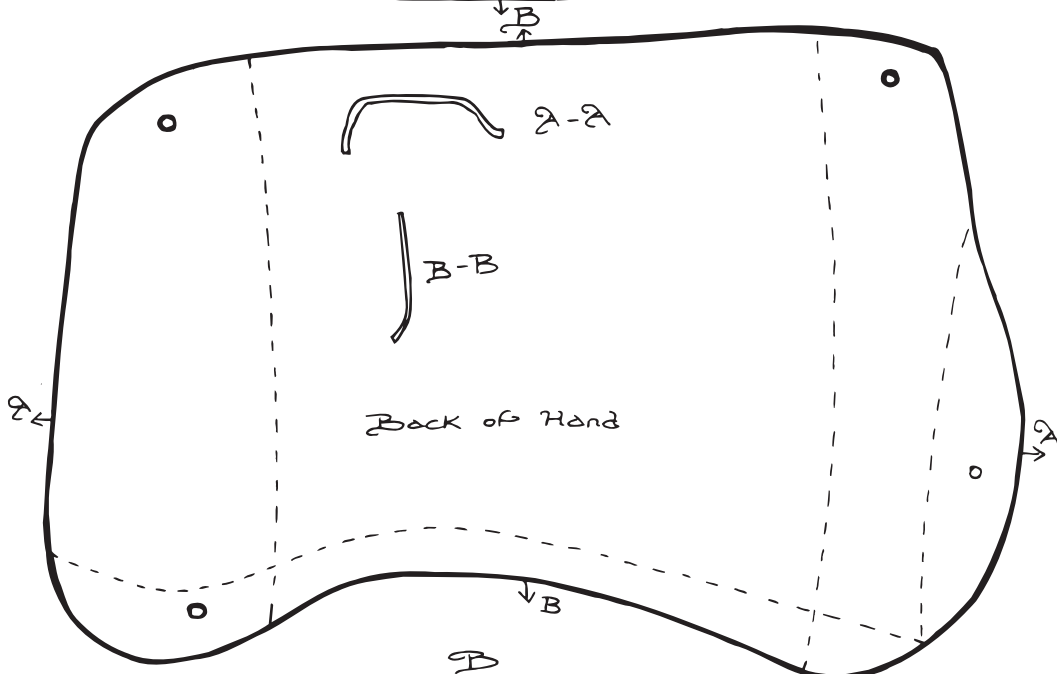
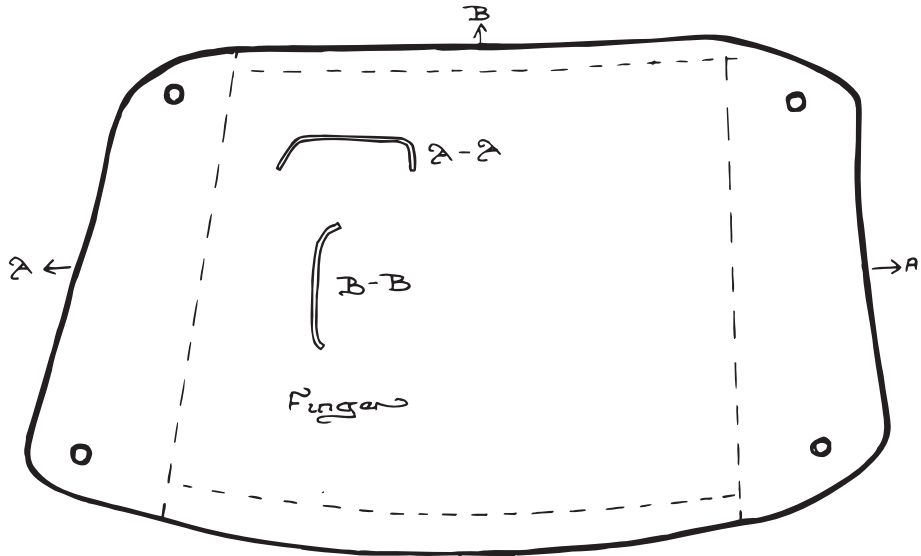
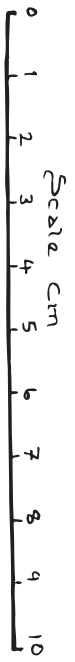
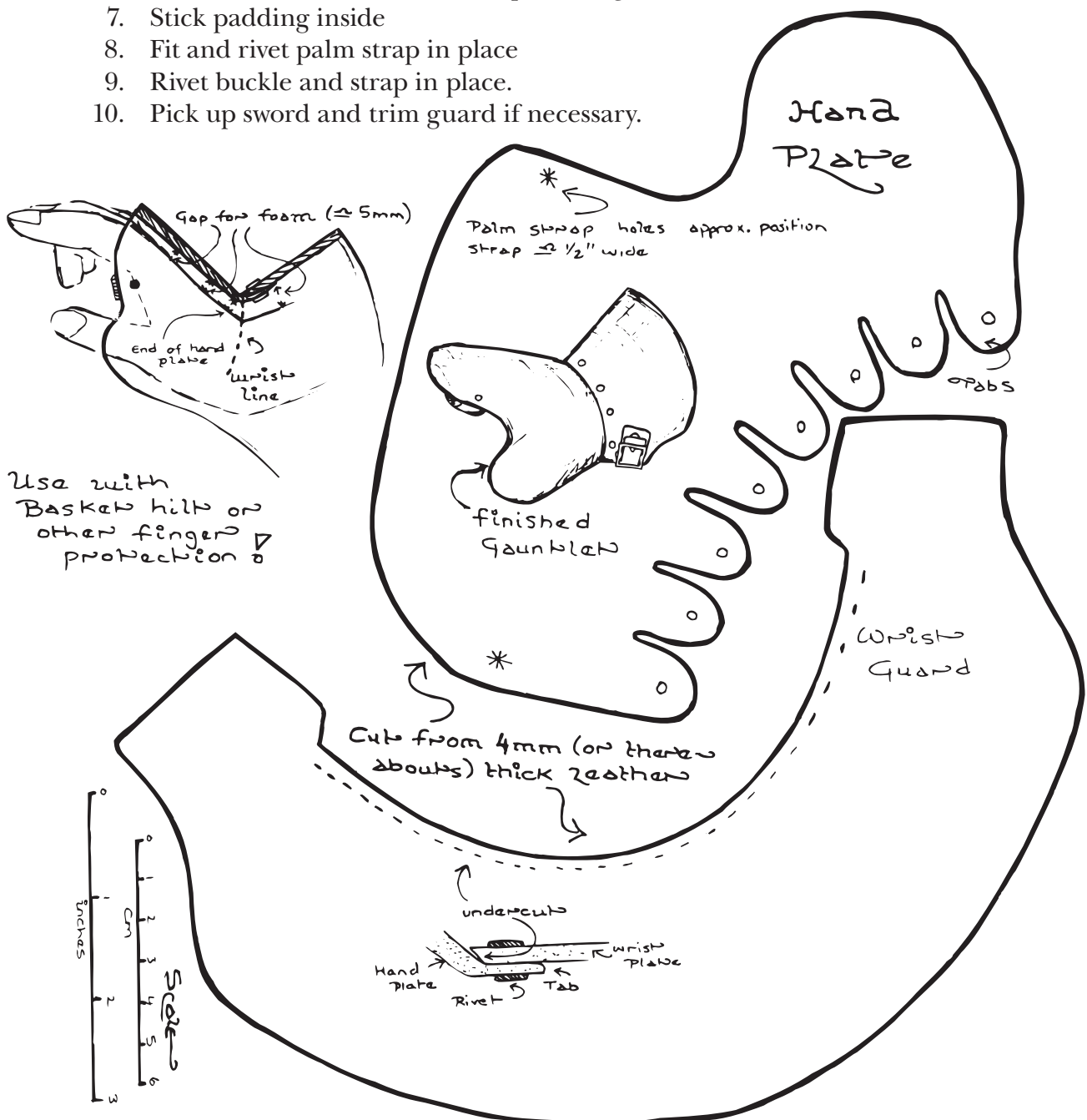

Figure 13-6: Patterns for Simple Gauntlets (cont.)

Leather Demi Gauntlet

Basket hilts are a good way of protecting the hand. Unfortunately they leave the wrist and back of hand unprotected. A demi gauntlet provides protection for these areas.

1. Cut out the pieces remembering to allow for padding. Note how the hand plate does not go all the way to the bend line of the wrist.
2. Punch holes for rivets in hand plate tabs.
3. Bend tabs to fit inside wrist guard (thinning if necessary).
4. Mark the position of one of the central tab holes, inside the wrist piece, then punch out a hole at this point.
5. Temporally hold the two pieces together with a nut and bolt and mark correct position of holes for rest of tabs.
6. Punch holes then rivet the two pieces together.
7. Stick padding inside
8. Fit and rivet palm strap in place
9. Rivet buckle and strap in place.
10. Pick up sword and trim guard if necessary.



HANDS



Chapter 14 — Legs

Your legs are the bits that poke out from under your shield and are therefore prime targets. The place you are most likely to get hit is on the outer side of your leading (shield side) leg, unless you meet an opposite handed fighter in which case you will probably be hit on the inner side of this leg (ah the joys of being sinister). The most dangerous place to be hit is on the knee and this should obviously be well protected. Getting hit on an unarmoured lower leg hurts a lot too! While I'm at it I'll mention the extremities of the legs. At the bottom you will hopefully find some feet, which are best protected by a pair of sturdy boots (with ankle protection) and at the top you will find the groin area which can be protected by a *box*. The flat Cricket style box is pretty useless for running about in so buy a better shaped martial arts, hockey or contact sports one. Get a decent holder too while you're at it. Female fighters see advice in Chapter 18.

Padded Legs

A style of armour often seen in early 14C illustrations worn over mail. A shortened version often had a decorative border of leather or fabric along the bottom edge. The design is also ideal as hidden armour; see Chapter 18. The padded hose should be made of several layers of heavy canvas or calico stuffed with cotton or other padding. The *cuisse*, thigh covering, should be quilted vertically and either padded quite thickly or backed with a rigid material, for example leather or plastic. The area of the knee should be quilted into 3-5 sections and stuffed quite full of padding to adsorb the force of any impact on the metal cop. It is also worth padding the area below the knee quite well to protect from shots that glance off the cop. The padding can be extended all the way down the shin, ending in a foot stirrup, or ended about 6 inches below the knee area. The long version is good if you plan to

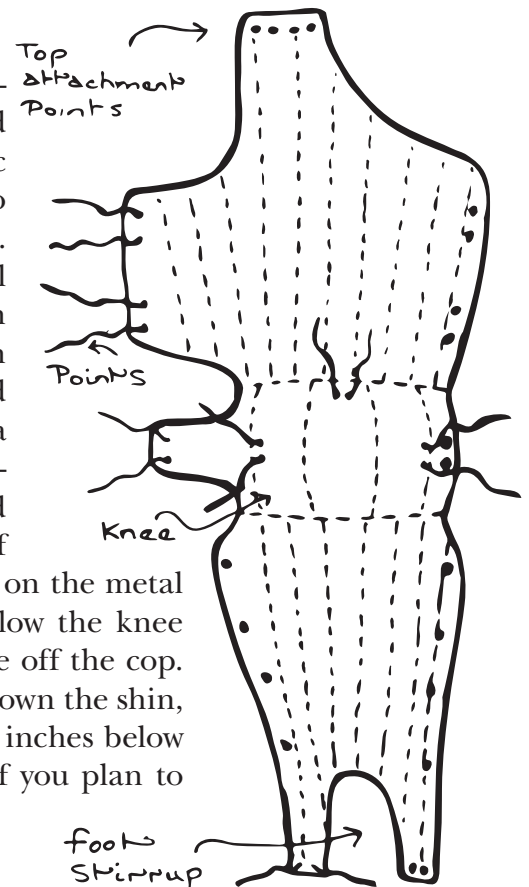
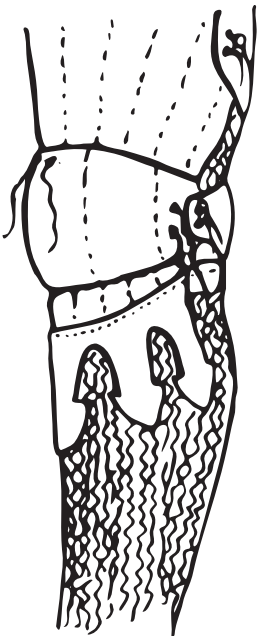

wear greaves (lower leg armour) the short version better if you want to wear full mail legs. The knee cop is a variation on the *floating cop*, described below, fastened onto the padding by three sets of arming points. The cop should be fairly large so that it covers the entire knee, even when bent.

Splinted Upper Legs

These are made in the same fashion as splinted arms, see Chapter 12. Adjust the shape shown to fit your leg then cut from thick hide. Add splints to strengthen. Because most re-enactors fight on foot their armour can come further round the leg (giving more protection) than period examples designed to be used on horseback, where a considerable part of the leg is protected by the saddle/horse. The advantage of a flexible material such as leather is that you can wrap the armour as far around the leg as you like without worrying about how you will take them on and off!

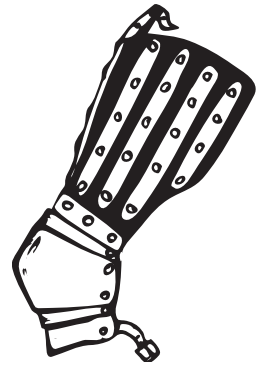
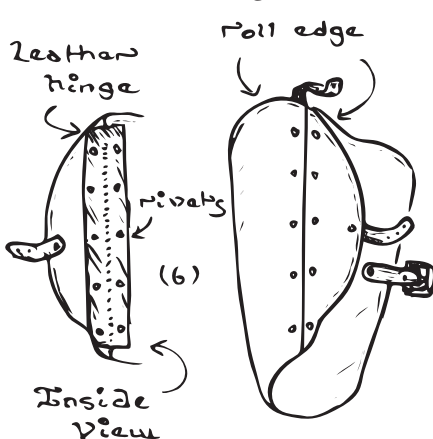
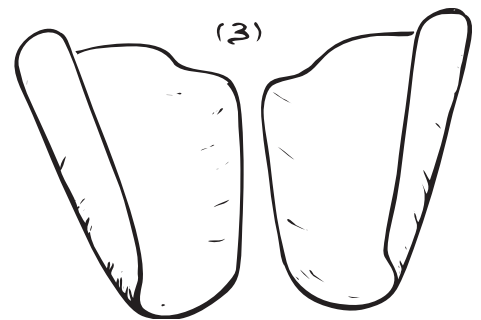

Plate Upper Legs

The pattern can also be used for Cuir Bouilli or thermoplastic; the latter should be covered with leather or cloth or worn as hidden armour. The instructions below are for steel; adapt as necessary. Because these materials are less flexible than the padding and leather types described previously a hinged rear flap is necessary to protect the back of the leg (and still let you get into the armour!).

1. Adjust the pattern changing the length and width to suit your leg. Remember to allow enough gap at the back to enable you to slip it on your leg!
2. Transfer the pattern twice to a piece of steel (you have two legs don't you?)
3. Bend the legs into the half cone shapes shown and then adjust this shaping to fit snugly around your leg with allowance for padding.



4. Cut out the rear flaps bend into a curve to fit the back of your leg then file the contact edges to give a smooth joint with the main piece of the leg armour
5. Roll the top edge the main piece and side edge of the flap to give additional strength
6. Join the two pieces, of each leg, with a leather hinge.
7. The legs are now ready for final assembly as described in last section of this chapter.

LEGS

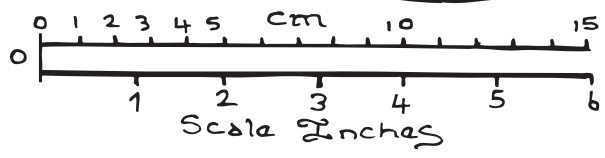
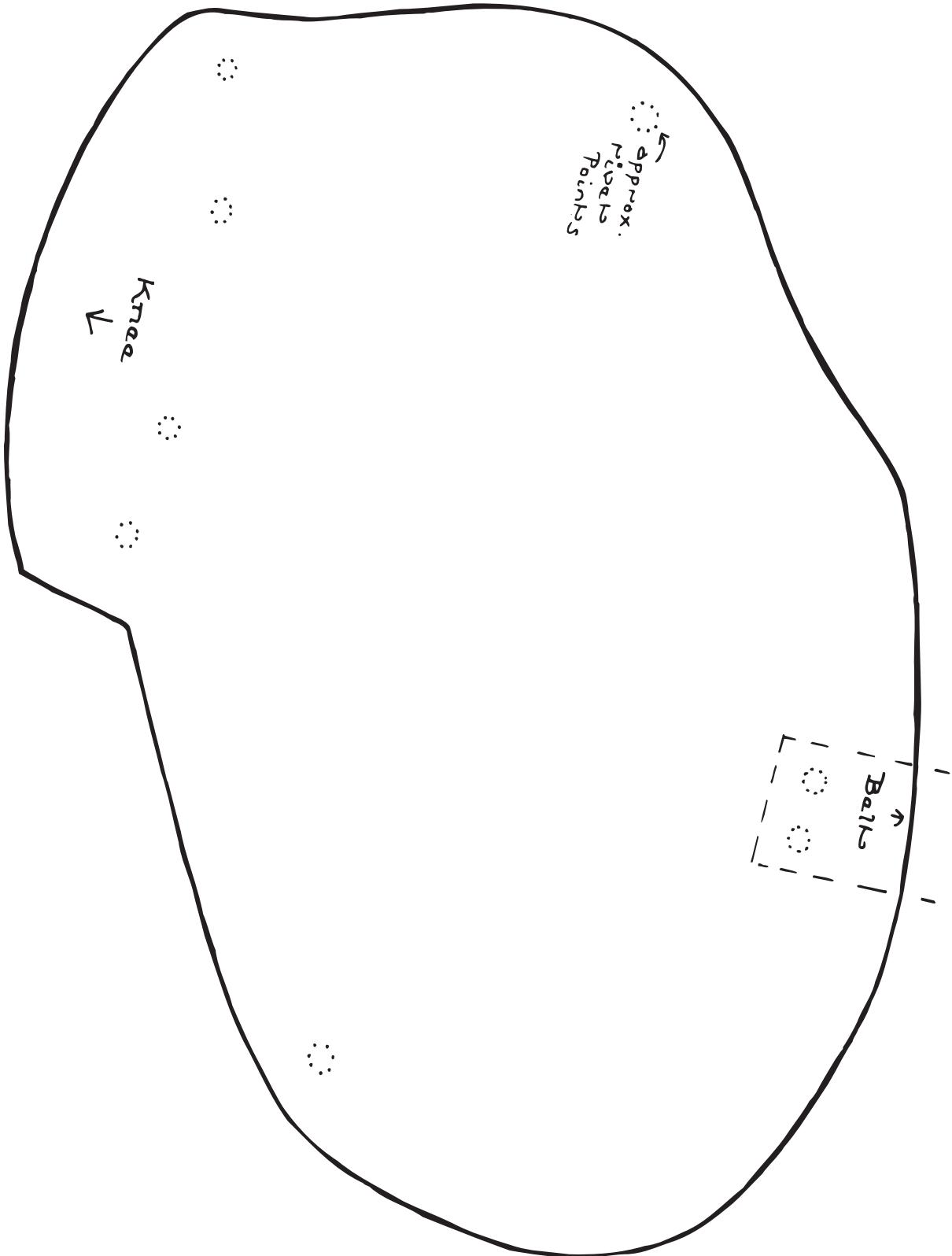

Figure 14-1: Splinted Upper Leg

LEGS

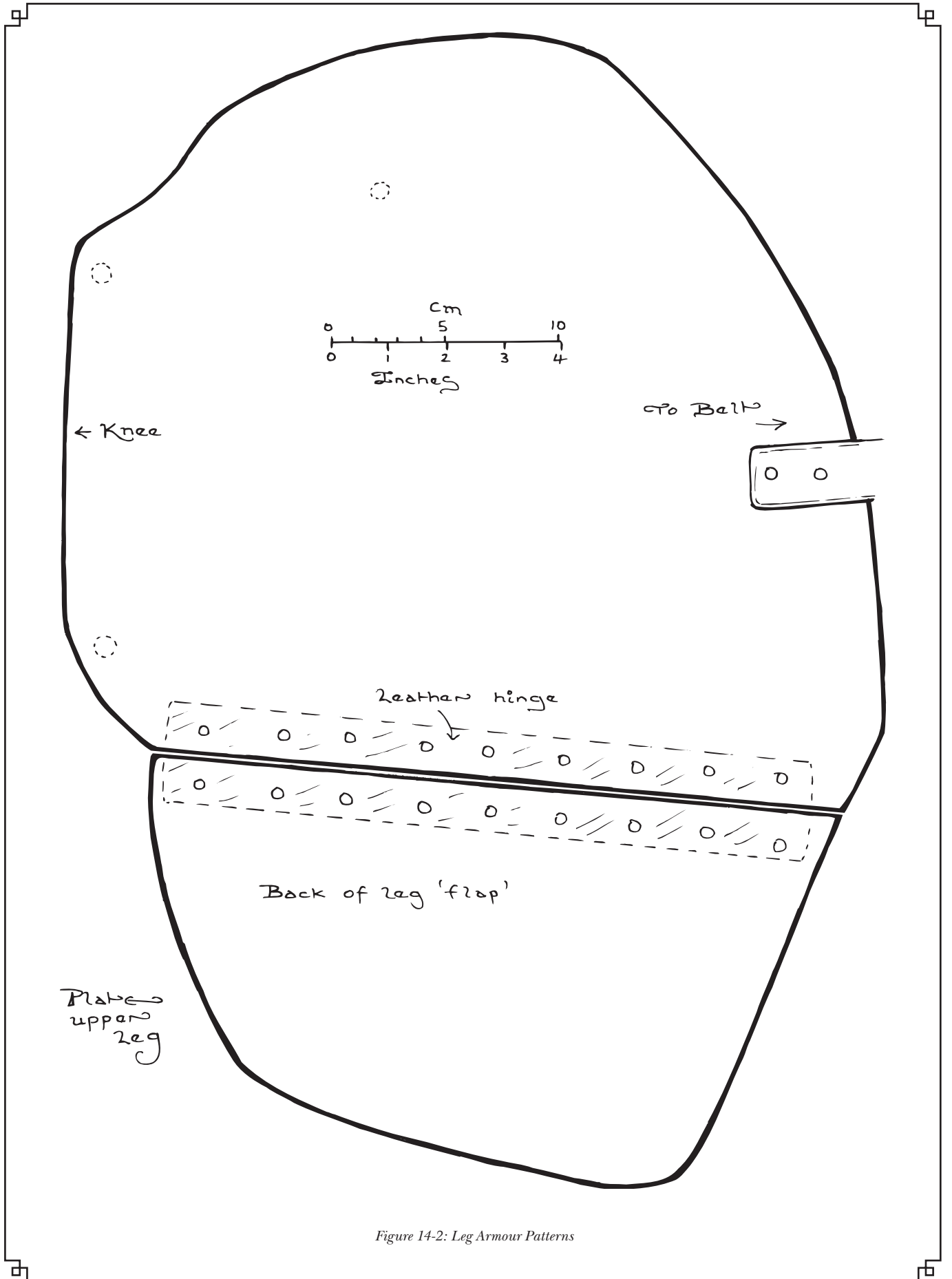

Figure 14-2: Leg Armour Patterns

LEGS

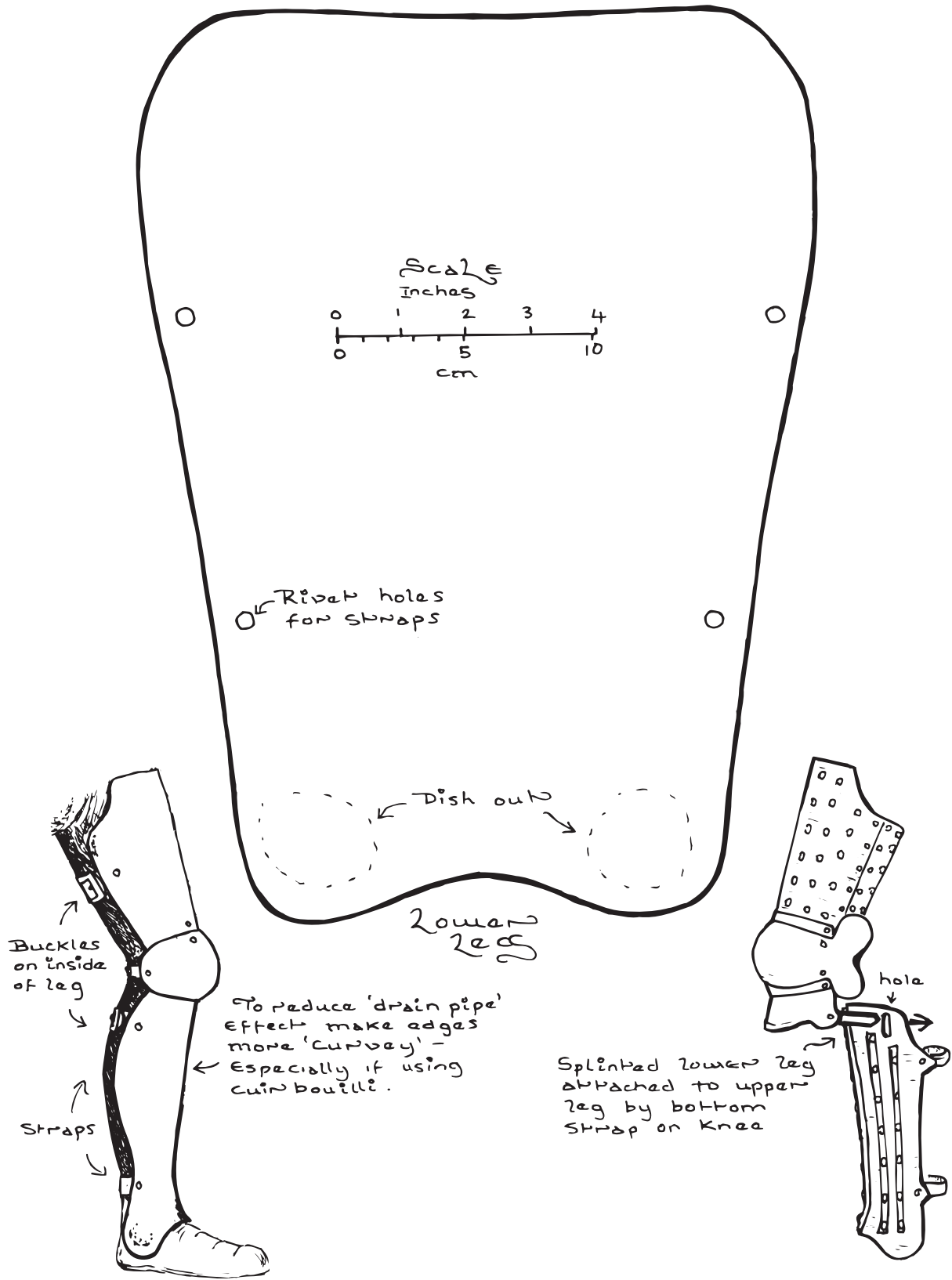
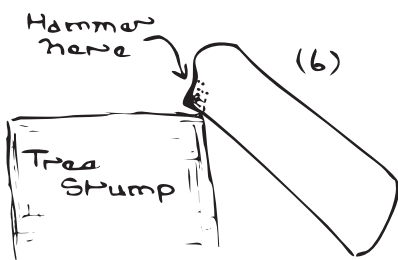
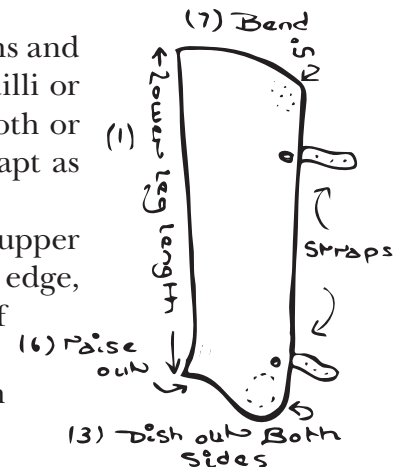

Figure 14-3: Leg Armour Patterns (cont.)

Lower Legs

This is armour, often referred to as *Greaves*, to protect the shins and ankles. The pattern can be used with leather, steel, Cuir Bouilli or thermoplastic; the latter should be covered with leather or cloth or worn as hidden armour. These instructions are for steel; adapt as necessary!

1. Measure the length of your lower leg and, allowing for upper leg armour, adjust the pattern to fit your leg. The bottom edge, or lower plate, of your knee cop should rest on the top of your lower leg armour.
2. Transfer pattern to steel and cut two out (one for each leg).
3. Dish out the two ankle covering areas



4. Bend the metal into a tube; the top should be slightly wider than the bottom.
5. Place the tube over a former and hammer out the area above the foot. This prevents the edge of the steel from resting on your foot and trying to cut

through your boot; which is painful!

6. Bend out the ankle covers to fit your foot.
7. Bend in the top corners with a rubber/rawhide mallet.
8. Add buckle and straps. The buckle should go to the inside of the leg.

Floating Cop

This is an early style, one piece, protector for the knee. Simply cut out the shape shown then dish to fit around your knee. It can either be laced to your leg padding or hung from the upper leg armour.

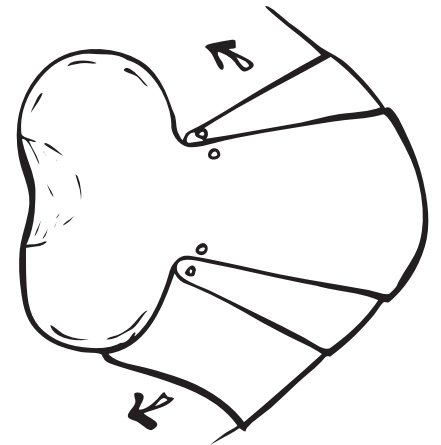

Articulated Cop

This is a later design, which, while being more difficult to make than the floating one, gives far better protection. The articulated cop shown consists of five pieces, the upper and lower articulation plate's act in the same fashion as those on an elbow and allow you to flex the knee to sit or kneel down. The bottom articulation also allows the knee to flex in the opposite direction. This permits you to fully straighten your leg if, for example, you want to sway back to avoid a blow or put you feet into a stirrup. If you have made an elbow cop then a knee should be no problem—which is why I haven't gone into huge details below—see Chapter 12

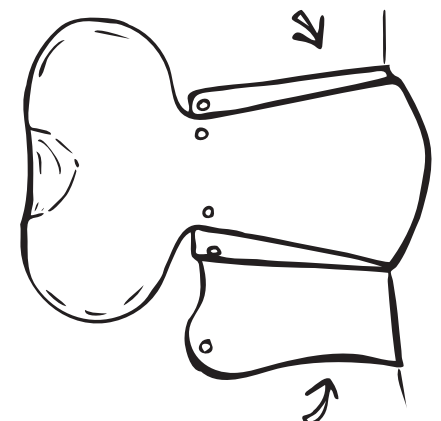

LEGS

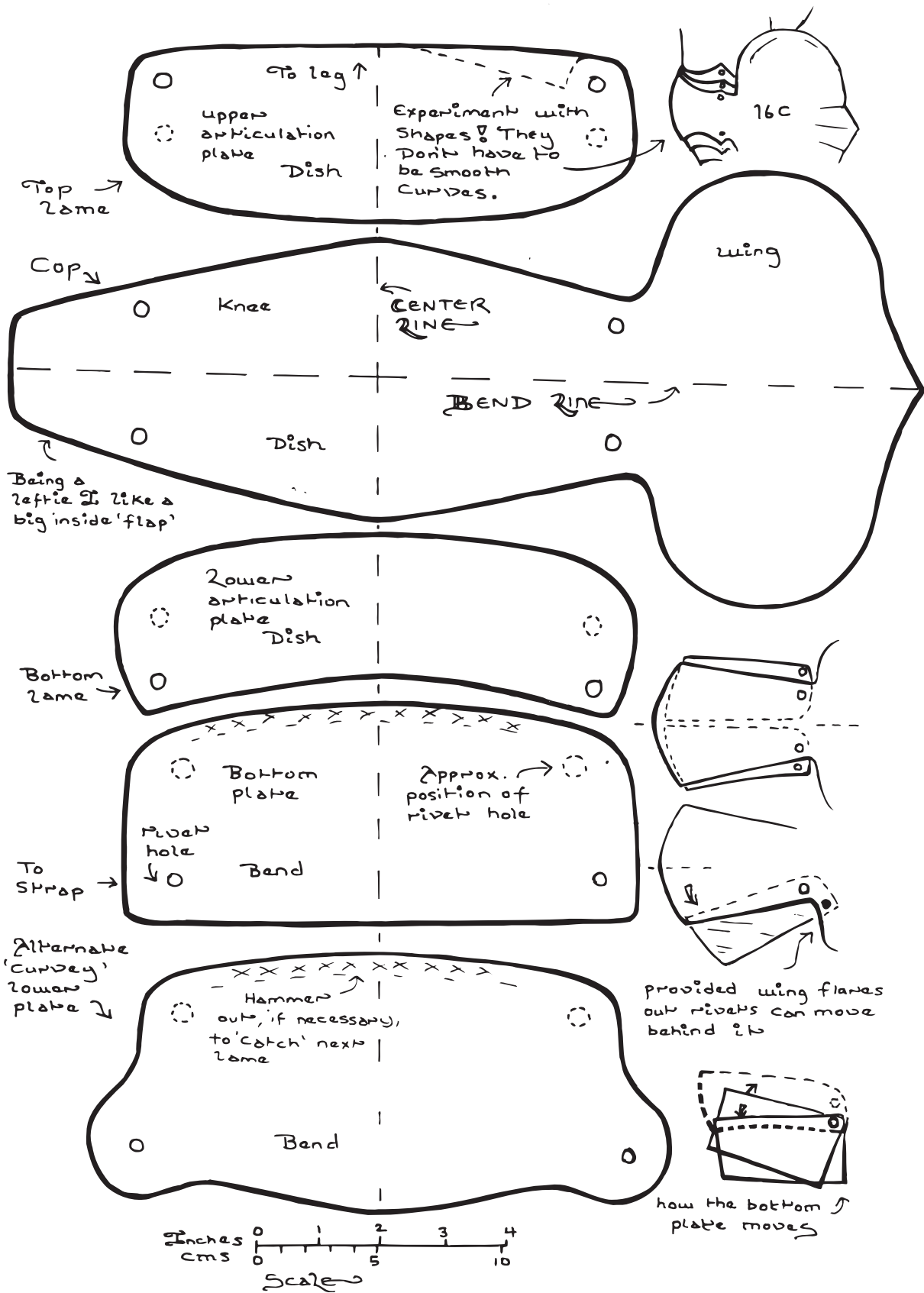
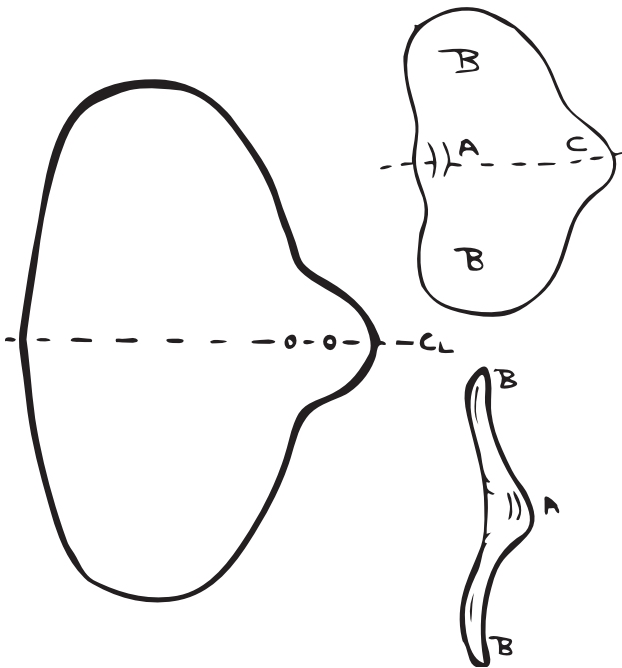

Figure 14-4: Templates for Knees

LEGS

if you have any problems. Remember it is best to bolt everything together until you have got all the plates to work!

1. Cut out the cop and dish it to shape.
2. Cut and shape the upper and lower articulation plates.
3. Cut and shape the bottom articulation. It articulates to the plate above in the normal fashion.
4. Cut and curve the bottom plate to fit around the top of your lower leg armour. This plate needs to articulate forward; you don't need much movement, just enough to stop it digging in when you straighten your leg fully. When looking for the articulation points make sure the plate catches when flexed in either direction; or else it will gap when you kneel down or worse still jam open.



Fan plate

As with elbows the cop can be made with or without a fan plate. The plate illustrated is made as follows:

1. Bend the plate to give a curve along the centre line C_L .
2. Dish the area marked A inwards with the ball end of a small hammer. Bending this in will bend the two wings B out. The curve produced by the A part will help protect the back of the knee.
3. Bend the two wings out a bit further by beating them over a convenient former. Take care not to lose the lengthwise curve whilst doing this.
4. Shape the area marked C to match the side of the cop (or 'blend it in' for a open piece cop-fan construction).
5. Check the fit and adjust as necessary. Area A should curve around the back of the knee but not get in the way when you are kneeling down. The two wings should stand proud of the rest of the leg armour without sticking out at a ridiculous angle.

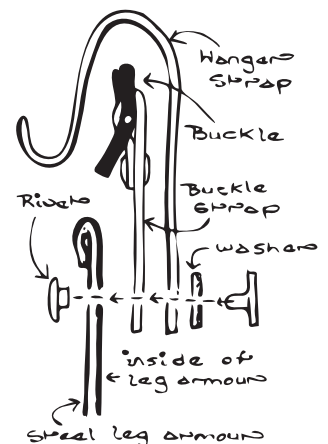
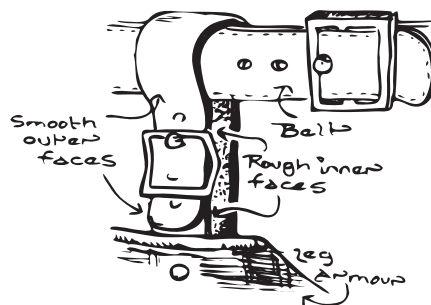
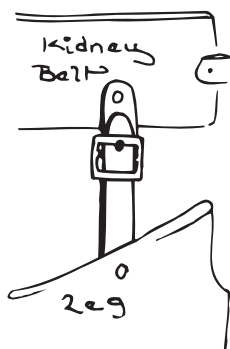

Hanging and Assembly

There are several ways to hold your legs up. The most authentic is to attach a leather flap to the top and use this to point them onto your gambeson. A common method is to buckle them to a kidney belt for which you require a buckle on the belt and a strap at the top of the leg harness. Another method is to hang over a hip belt by means of a strap and a buckle attached to the leg.

You will also need strapping to hold the armour to the leg. You can use a single strap, or make a Y strap as shown in the illustrations. For more flexible armour you might want to consider two straps. The buckles should go on the inside/rear of the armour where they are less likely to be struck and won't catch when you run; hey, you don't want to spend your entire life standing in a shield wall do you?

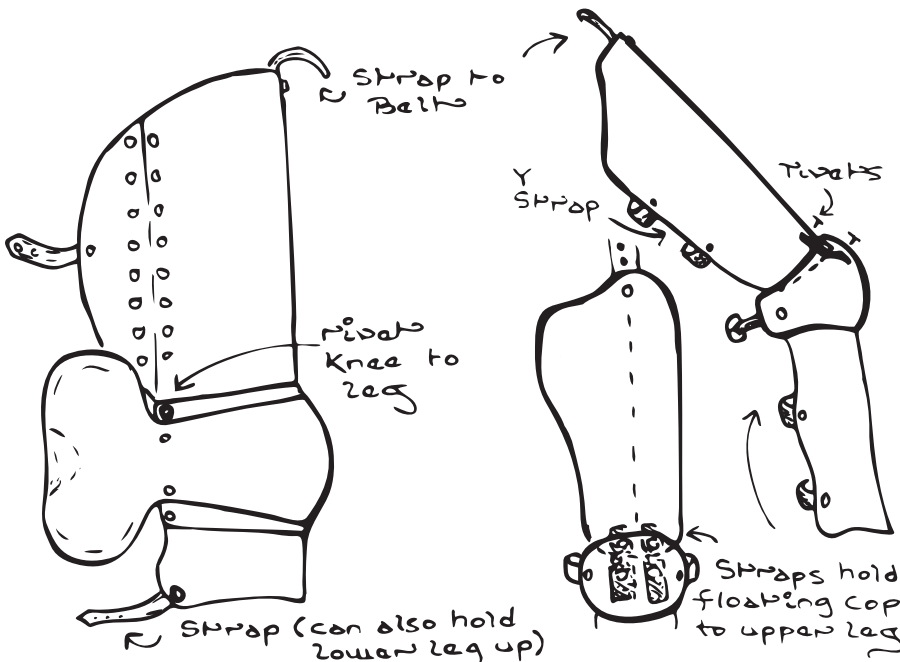
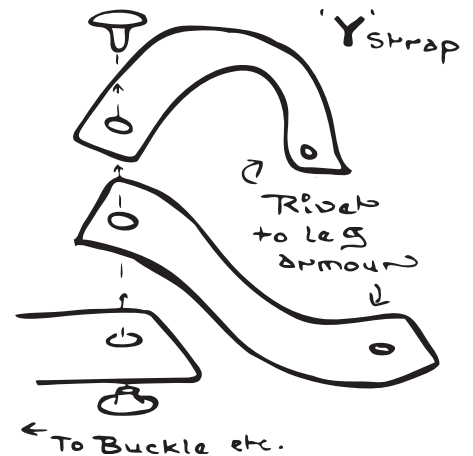

A floating cop will require a strap around the back to hold it in place. I find a strap around the lower plate of my articulated ones holds them well, and a strap at the back of the knee merely gets in the way when I kneel.

Floating cops can be hung from the upper leg by the use of two straps. Alternatively they can be pointed in place. Articulated knees are simply riveted to the upper leg armour which is where those long

rivets can come in handy! If you are riveting the cop to a soft or non hard wearing material (leather, Cuir Bouilli, thermoplastic, etc.) be sure to use a washer between the material and the peined head of the rivet or the cop will soon fall off the leg!

LEGS

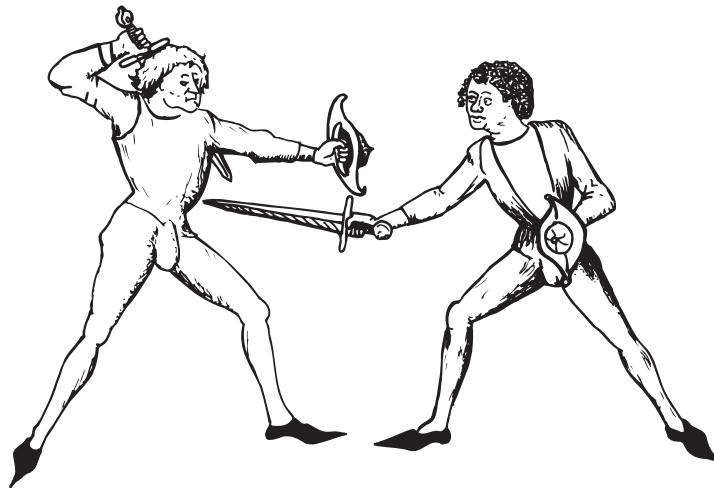

Chapter 15 — Shields

Shields are generally made from 12 mm (1/2 inch) plywood (marine ply is best). Less authentic, but longer lasting, shields can be constructed from *Dural*, aircraft grade aluminium. Small bucklers can also be fabricated from steel. Shield size is very much a case of personal choice. Some brave souls do incredible things with tiny bucklers, others provide sterling service in the shield wall with things that look like barn doors—the rest of us have something in between! Experiment until you find a size and shape you like.

Hand and Arm Protection

If you have a nice BIG shield no blow can get behind it, right? Sorry—wrong—axe and halberd heads come inside shields, people can hook your shield open exposing your hand and arm, and crafty people will always find ways of getting in shots behind it! Whilst not as vulnerable as a weapon holding arm the shield arm still needs protecting, in particular the fingers, hand and elbow.

Facings, Shield Edging and Padding

The simplest facing you can give a shield is none at all—yes wood is period! A nice effect for Viking shields, and the like, is to carve a few small grooves to give fake planking. Protecting a shield against the elements is, however, a good idea and even a ‘wood effect’ shield can benefit from a coat of matt varnish. Once the strap and grip fitting holes have been drilled the face of the shield can have a layer of cloth glued to it, which both protects it from blows and gives a good surface for painting. For heraldry and the like you need a layer of undercoat (you need a special non-ferrous metals one for *Dural*) followed by a topcoat of household enamels or similar paint.

Shield edges can be protected, either to stop them being chewed up when struck or, when non-steel weapons are being employed, to pad the shield to stop it destroying weapons! Edging a shield

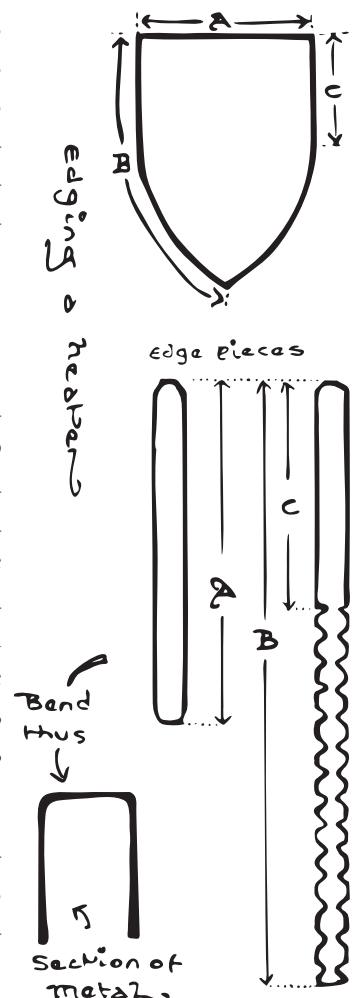

SHIELDS

also makes it safer to use as a jagged, splintering edge is a hazard to both you and your opponent.

The most epic thing you can do to the edge your shield is to cover it with 20-gauge steel. Simply cut a strip as shown, fold it around the edge and rivet it on—of course this won't actually make it last forever but it may seem that way after you've lugged it around for a bit! A lighter, more practical edging can be made with rawhide leather. This can be purchased in convenient strips as dog chews; but I suggest you avoid the flavoured ones! Simply soak in water until soft, cut to size then tack on and allow to dry. A coating of paint stops them going soft again after fighting in the rain, any time during the British summer.

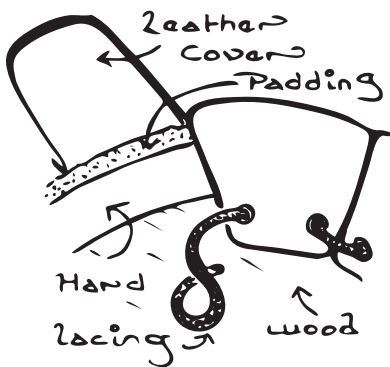

There are several ways to pad a shield edge but first edge it, even if it's Dural, with rawhide—this stops a wooden shield disintegrating and the hard edge of a Dural one cutting straight through the padding. You now need to add something resilient over these edges don't need to be soft for most combat forms, they just have to have enough give to make weapons last more than one blow. Sticking a layer of felt on

works as does split rubber tubing, water hose, thick leather and the like. Finally you need to hold everything in place. Felt or soft tubing will need something tough such as a layer of leather over it, thick tubing (unless it's a really horrendous colour) or leather can simply be laced in place.

Round, Heater and Kite Shields

Flat, round shields are very easy to make; buy a piece of plywood, mark out a circle then cut it out (a jig saw speeds things up).

Heaters and kites can be made either flat or curved. If you can't work out how to do a flat one then you haven't been paying attention! For a curved one buy two (or more) pieces of ply whose combined thickness come to about 12 mm (three layers of 4 mm works well) and some waterproof, slow setting, wood glue (e.g. Cascemite). Glue the pieces together then either curve the wood over a former or simply pull it to shape with rope. Ply tends to bend better in one direction than the other so assemble the pieces to curve the easy way! Allow to dry then cut to final shape.

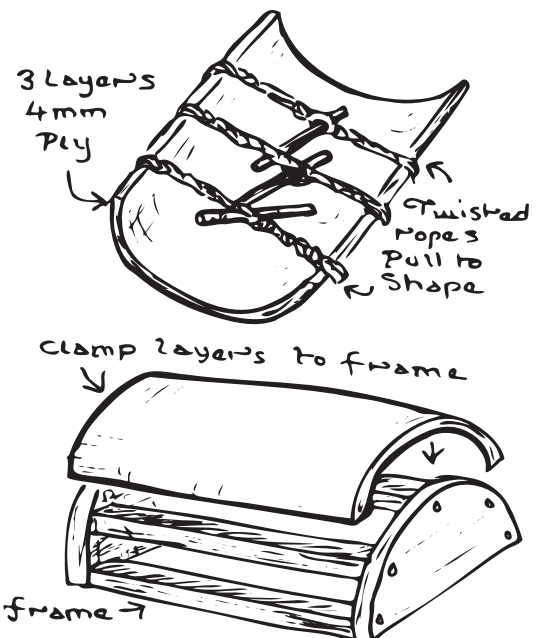

Centre Grip Shields

These require a boss to protect the hand and a gauntlet to protect the wrist. If you are feeling lazy go and buy a spun boss at a re-enactors market! Failing that dish one out or, for a really deep one, build it up like a mini domed top helm. Viking rounds are large wooden centre boss shields; wooden bucklers are simply

SHIELDS

a mini version! To fabricate cut the wooden round then cut out a hole in the centre to fit your hand. Rivet the boss, over the centre hole, using two of the rivets to hold the handgrip in place. An alternative way to make a buckler is from a thick piece of steel (14 gauge or so). Dish the centre, roll the edges then add a handgrip. The shape of the handgrip will depend on the depth of your boss, the size of your hand and how you like to use your shield. I make mine from bar stock with a wooden covering for the hand; other people prefer a wrapped leather covering.

Shield Fittings

It should be emphasised that shields are very personal items. How a shield is hung will depend on the length of your arm, your preferred hand/wrist angle and to a large extent how you use your shield. The most important point is that your shield should feel comfortable in the normal *guard* position. If it's putting a strain on your arm/wrist at this rest position then it is going to cause a lot of discomfort at the end of the day; anyway you are supposed to be fighting your opponent not your shield! Additionally remember to keep the elbow free; straps that cut into the elbow are very annoying! Unfortunately finding the ideal position is largely a matter of trial and error keep experimenting until you find that perfect shield.

Handgrips

For a simple handgrip take a large door handle, raise it to a comfortable height above the back of the shield (with wooden spacers) and then bolt it in place.

Cutting the required shape from a piece of thick, stiff leather can make a flexible grip.

You can make a solid grip from a piece of around 2 cm (3/4 inch) wide strip of 14 gauge or heavier bar stock. The approximate size is shown below, however as your hand is unlikely to be the same size as mine make a cardboard template first then adjust the size to fit before cutting the metal up. Remember to allow room for your glove or gauntlet.

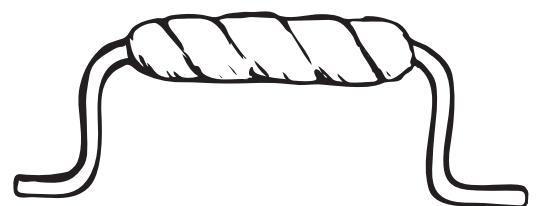
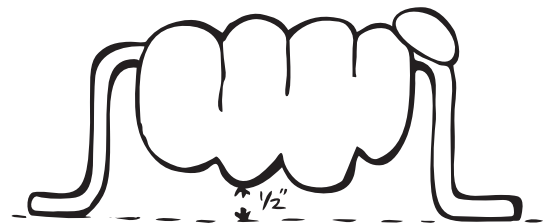

Hand Grip

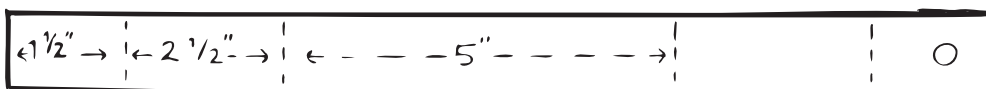

1. Cut out the metal strip, drill two holes to take your bolts then bend into the shape shown.
2. Glue a piece of wood to either side of the metal then cover these with leather to ensure a comfortable, non-slip grip.

Arm Straps

The most basic form of arm strap is made by bolting on two crossed straps of 4 cm (1.5 inch) wide leather to the shield. Another simple grip is a single piece of leather, shaped to your forearm, attached to the back of the shield. If you are using such unadjustable fastenings then you will need some way of holding the shield on your arm. To this end you can either use thick, spongy padding behind the straps or else hang them as shown to right thereby using the weight of the shield to hold it in place.

Personally, I much prefer adjustable straps, if only because they are so much easier to put on and take off! They also allow for changes in padding, arm armour and the huge increase in your forearm muscles as you diligently practice for several hours every day! Several attachment methods are shown in figure 15-1—take your pick.

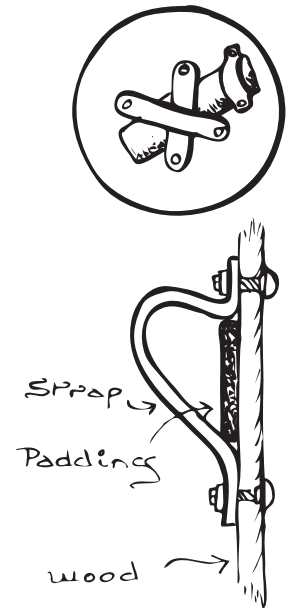

Padding

Shields tend to get thumped pretty hard so unless you have some padding, between it and you, you are going to end up with a sore arm! This padding should extend from just behind your elbow to either your wrist or hand depending on the type of gauntlet you plan to use. Felt or close cell foam covered in cloth or leather will make a perfectly adequate pad.

Hanging

The final stage is to attach all the bits to the shield. Coach bolts are good for this, as they don't protrude at the front. Alternatively you could rivet everything on, the major disadvantage with this being that it is then difficult to transfer the fittings to another shield when the wood on the original gives way. Remember to cut off any protruding length of bolt flush with the nut—you don't want to impale yourself on your shield now do you? It is also important that your hand and elbow aren't too close to the shield edge as axe and halberd heads can strike over it. Even then blows can still come inside a shield (especially if it's hooked by a pole arm) so don't throw away your hand protection and shield arm elbow cop.

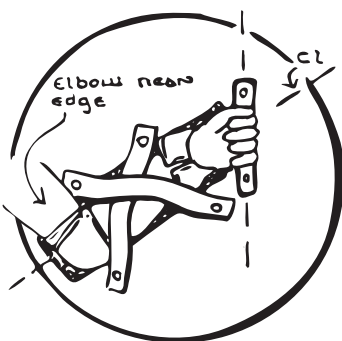

For a round shield lay your arm along the diameter with your elbow at least 5 cm from the edge. Next, with the padding under your arm and holding onto your handgrip, move your wrist about until it feels right. Mark the positions for the bolts through the holes in the grip. Then lay your straps over your arm and mark their bolthole positions as well. Temporally rough tack or screw everything in place, put the shield on rotate it a few times and carefully try a few blocks. Adjust the grip and strap positions until the shield feels comfortable,

does not twist around the arm and does not put too much strain on the wrist. After adjusting glue the padding in and bolt everything else in place.

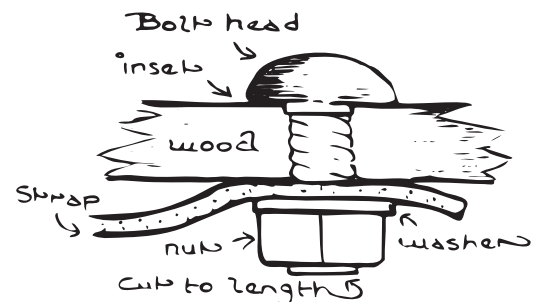

SHIELDS

To hang a heater you first need to find how it balances. Hold the shield, and a plumb line (bit of string with a weight on the end), on the corner nearest to where your hand will go. Allow the shield to hang naturally (as shown below) then mark the position of the plumb line onto the back of the shield. Using this line is a first estimate of where your arm will go roughly attach the grip and straps (tacks work quite well) to the back of the shield. You will want your hand to be at least 8 cm from the edge (thereby avoiding axe heads etc.) and your wrist at a natural angle. Next carefully move the shield up and down a few times adjusting the placement of the fittings until they feel comfortable; don't do anything too dramatic or the shield is liable to fall off onto your foot! Once they are positioned to your satisfaction bolt them in place and glue in the padding.

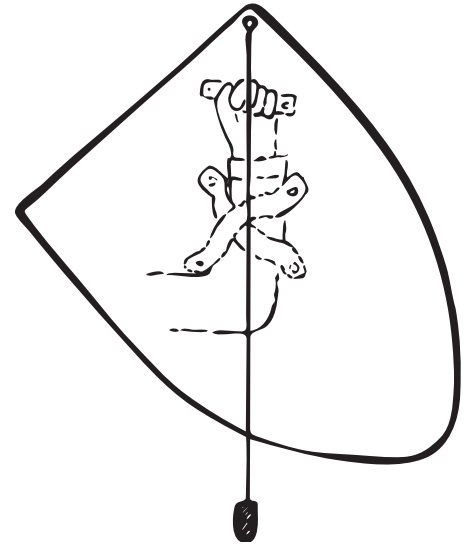

SHIELDS

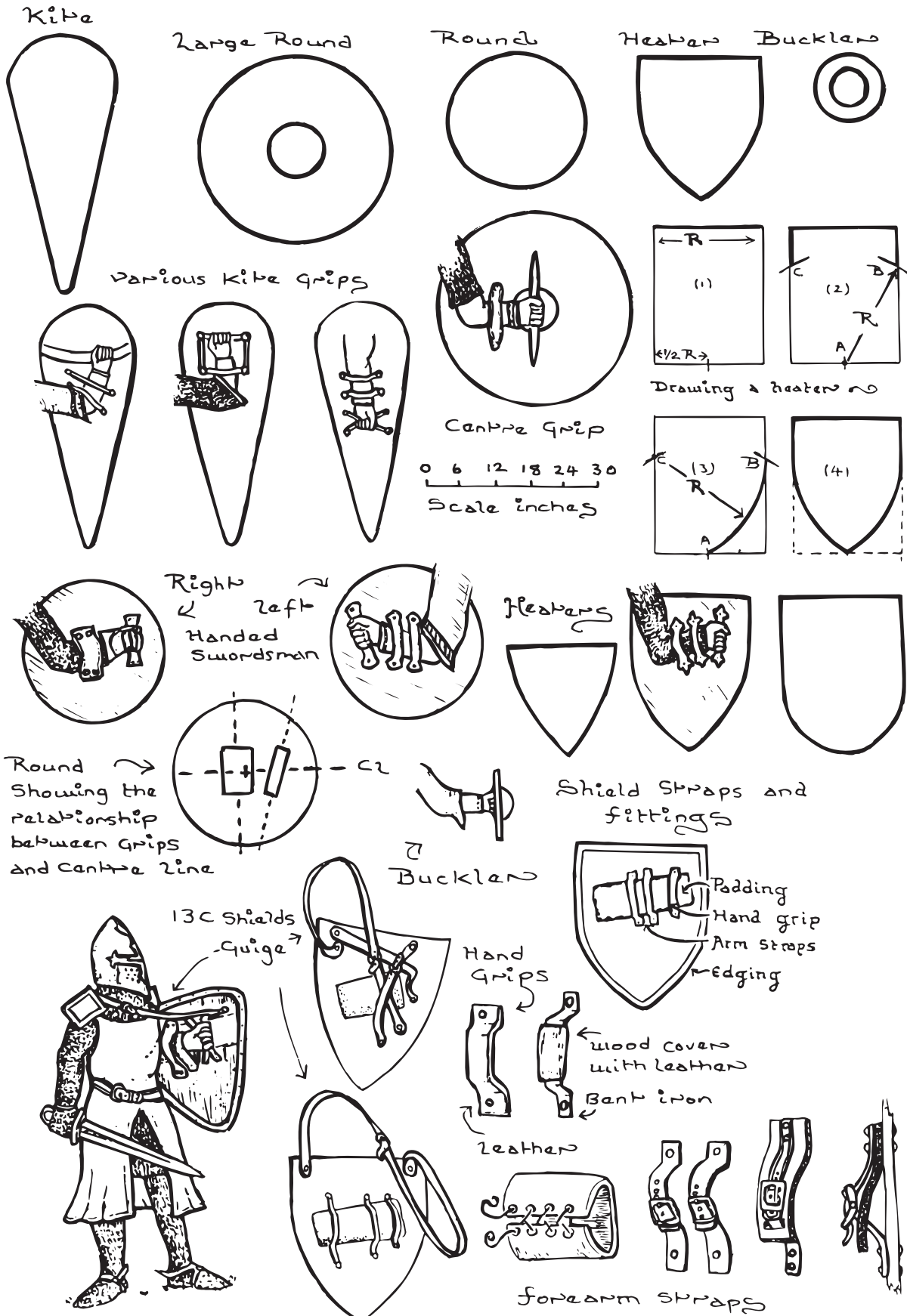
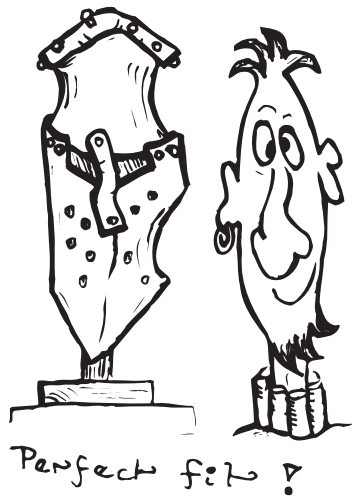

Figure 15-1: Shields



Chapter 16 — Maintaining Armour

When armour gets hit it absorbs part of the impact by deforming. It should therefore be obvious that if you don't straighten it out it won't work as well next time it gets struck.

It is vitally important to regularly check your armour for dents, cracks, lose rivets, breaking straps, slipping padding and the like.

The easy way to remove a dent from one side of your armour is to hit it on the other side with a hammer! Legs and the like can normally be beaten back into shape, in this manner, over a suitable former, a bit of wood works well. Remember to take the padding out before hammering.

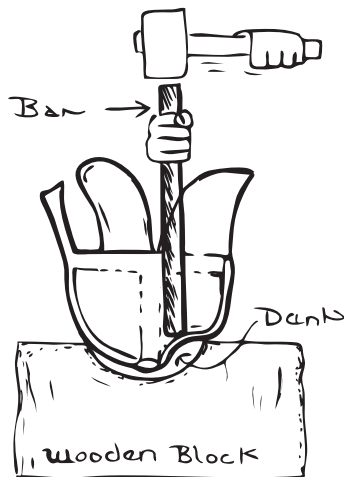

Helms can present a problem because it is difficult to wield a hammer inside their narrow confines! A simple way to get around this is to use a metal bar as shown below. Another way is to push the helm back into shape with a car jack (a small hydraulic one works well). Support the undamaged side with a piece of wood. This technique can also be used to reshape helms that have started to flatten inwards at the sides; barrel helms are particularly prone to losing their oval shape.

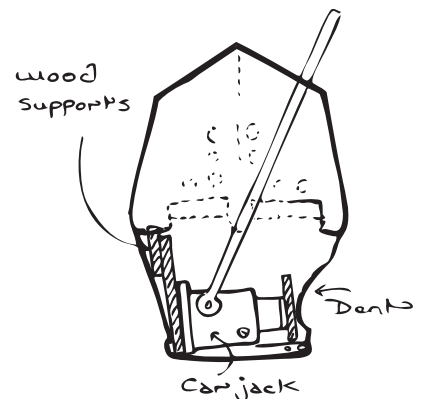

Cracks are worrying as they indicate material fatigue. If a crack appears somewhere important replace the cracked piece—at once! If you can't replace it bin it! Minor cracks in steel can be welded or braised back together again, however cracks are a definite case of "if in doubt throw it out!"

Straps should be replaced as soon as they show any sign of wear; having a strap break in the middle of a battle is not recommended; been there! Please note that holding your armour together with sticky tape is neither ascetically pleasing, period, nor safe! If a strap keeps breaking find out why. For example was it in the wrong place or does it require thicker leather?

MAINTAINING ARMOUR

Rusting will reduce the strength of your armour and regular polishing will gradually reduce its thickness. Painting the inside of your armour and coating the outside with oil, wax or polish will help to keep it rust free and make it last longer.

Padding will gradually become compressed, and hence less efficient, it gets regularly impacted. It's worth changing your helmet padding on a regular basis.

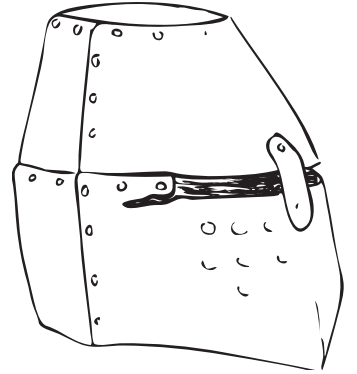
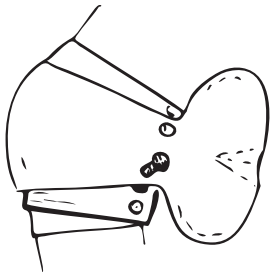

Remember, there is nothing dishonourable in retiring from a fight if your armour becomes unsafe—don't just fight on and get hurt!

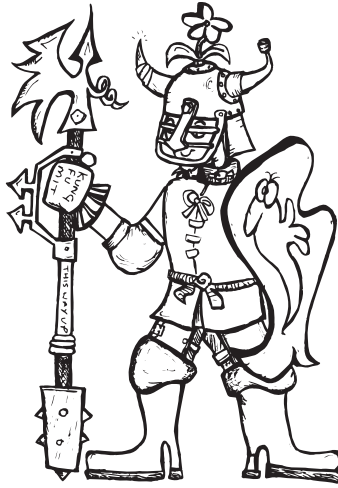

Chapter 17 — Authenticity

Re-enactors spend an inordinate amount of time arguing about *Authenticity*; which is interesting because I can't even find the word in my dictionary! It does however define *Authentic* as "genuine, not forged". If you accept genuine as 'made as in period' and forgery as a modern short cut then Authenticity becomes a measure of how *Period* your re-construction is. On these grounds wearing an exact copy of a piece of historic armour makes you authentic—or does it? Consider if you had been alive in the middle ages, rather than the original owner, would the armour have been made a different shape? Is wearing a set of armour designed for a caval-ryman authentic for fighting on foot, or worse still that of a king correct for someone portraying a rank and file soldier? Is the piece you are copying even in the same state as when it was made? I remember a lovely exhibit, at the Tower, of 16C armours and portraits of people wearing them. From the portraits it was clear that the armours were originally black, an effect that had long since been lovingly polished away! To complicate things further early collectors had the habit of altering pieces to make them into matching suits, so how original is the piece you are copying?

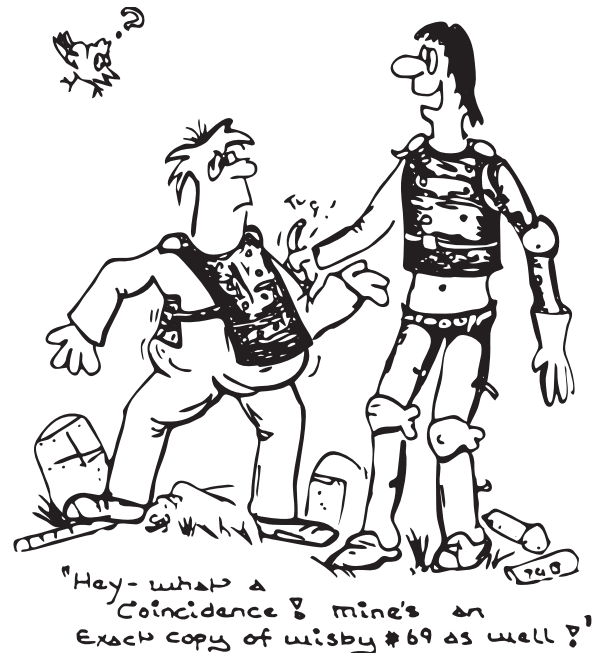

My first suggestion, therefore, is that it is better to try and understand *how* and *why* an armour was made rather than slavishly copy one of the few surviving examples. One can then set about designing one's armour, as the original armorer would have rather than just making a Chinese copy! This approach also has a number of advantages from the point of view of safety. Remember that, throughout history, armour has evolved to meet the threats posed to its wearers. We should therefore design our armour to meet the threats posed by our styles of combat. Unfortunately this attitude may lead to obvious differences from the original armours. For example although it is unlikely that all early medieval warriors had helmets most re-enactment societies now insist on them being worn!

AUTHENTICITY

If this is the case so be it—authentically you would expect a heroes welcome when you staggered back, battered and soaked in gore, from the battle field—try explaining this to your boss on Monday morning as you drip blood on his carpet!

But why all the interest in this rather nebulous concept of Authenticity in the first place? Quite simply the ideal is at the heart of re-enactment; without a historical background the hobby becomes nothing more than “funny people in fancy dress!” So a second definition might be *historical accuracy*, something that people aspire to at differing levels depending on their interest within the hobby. Some seek to put on an entertainment many wish to be educational, others to create a western martial art, a glorious few strive to get into the mind set of the period; all want to have fun doing it! Now for the practical part; how historically accurate do you wish to be? At the simplest level this entails hiding anything modern—a tabard works wonders! At the highest level it entails all aspects of your attire, from the boots upwards, to be accurate portrays of historical items. Me—I tend to air on the side of practicality especially as I tend to fly to various events around Europe at present. My old set of steel Wisby plates would take up considerably more of my baggage allowance than my current plastic lined Brigandine does. Both however look fine on the field. Hopefully the next chapter will throw further light on what you will need.

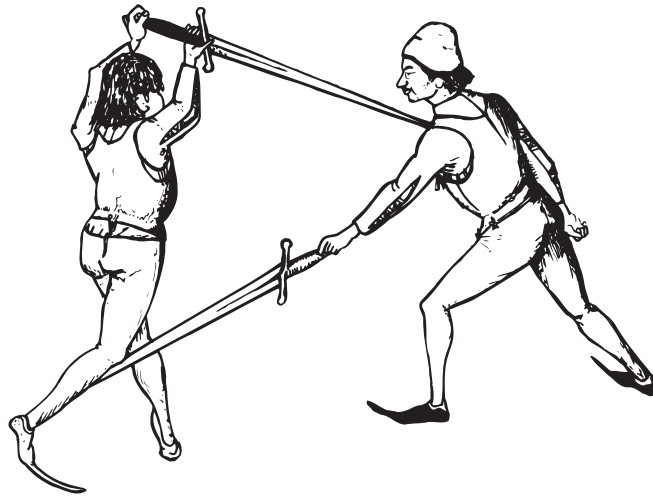

Chapter 18 — Fighting Styles

As mentioned previously peoples aspirations, in the world of re-enactment, can vary wildly. This is reflected in the various fighting styles that can be seen on the field, which, in turn, governs the amount, and style of armour you need to safely take part.

Controlled Styles

Style where control over blows largely determines safety.

Staged Combat

Employed by the more theatrical groups. Involves choreography, set piece moves or prearranged sequences. The aim is to entertain the crowd and armour is mainly there for show.

Live Role Playing

Uses soft lightweight latex rubber weapons to achieve a safe free form combat style. Armour supplies atmosphere rather than safety. Degree of 'realism' depends on group running event; one of the best Viking events I've been to was a LRP one.

Touch Combat

Employed by the majority of groups you will see putting on shows at historical sites around the country. It involves taking rebated (not sharpened) weapons and swinging them in a controlled manner. Blows are *pulled* so that they touch rather than strike an opponent. The degree of pulling varies from group to group, lightly armoured early medieval groups tend to use minimal force, later fully armoured ones can get quite epic! Armour requirements vary accordingly! In general though you are looking at armour to protect you when something goes wrong. Most groups use head armour (broken skulls, lost teeth and eyes are not recommended) and hand protection (because you will get hit there some day).

Full Force Styles

The emphasis is now on the armour to provide protection. For an early period look you are going to need to hide armour under you clothing, so called *hidden armour*.

Martial Arts

Groups such as the Academy for European Medieval Martial Arts and the Historical Armed Combat Association (check out their web sites) are trying to revive the works of Talhoffer and other masters as Martial arts in much the same way as the Japanese did for their traditional fighting arts. In a similar fashion various tourney societies are looking at the concept of Chivalry in the same light as Bushido.

Some groups use padded weapons, in much the same way as non-contact Karate clubs use flexible split rattan swords, others favour armour and full speed blows to evoke a sense of prowess. Tournament groups are particularly keen on authenticity in their endeavours to recreate the atmosphere of a period tourney.

Béhourd Style

Groups such as the Society for Creative Anachronisms, the Far Isles and many of the Tournament Societies use a combat system loosely based on the *Béhourd*, a tournament form using wooden weapons. This leads to an approach somewhere between a full contact sport and a martial art. Un-pulled blows are employed and armour is used to protect vital areas from damage and to cut down on bruising. Armour standards for such groups are high and must be met before you can enter the list. Authenticity is, however, not necessarily a priority as the major concern is safety.

Female Fighters

The differences between armour for men and women are fairly minor:-

1. Women tend to have larger hips with less fat (natural padding) covering them. Since this is a fairly common target area tassets with good padding behind them save a lot of grief!
2. Groin shots do not do the permanent damage they do to a male—they still hurt a lot! A male box is useless so seek out a female one designed for Karate or other contact sports such as hockey.
3. The female chest comes complete with breasts—presumably to make up for the lack of beer gut that so many male fighters seem to like carrying about! The easiest way to protect them is simply to obtain a good sports bra or else to wrap a piece of material several times around the chest, which is apparently what people used to do before the invention of bras, and then shape the body armour to fit. Single breast cups of the Red Sonya style should be avoided as their edges can cut into the chest and plain old padding isn't really enough.

Left Handed Fighters

Us sinister people stand the opposite way around from the rest! In practice this means:

1. Your weapon holding hand will be pointing at your opponent's making mid blow collisions probable and increasing the chance of you being hit on the hand, wrist or sword arm.
2. Leg shots will tend to be directed towards the inside of your right leg, as opposed to the outside of the left leg for a right-handed fighter. Leg shots are also quite likely to slide up and hit you in the groin. To protect yourself from these tendencies add inner wings to your knee cops, make sure your leg armour wraps far enough around the side of your legs, and make absolutely certain your box fits!
3. Your shield is in the perfect position for punch blocking so check that the handgrip is soft enough to absorb the impact. I find a stiff leather grip preferable to a solid wood/steel one. You are also going to be hanging your shield at a different angle to a right-handed fighter.

Injury Prevention

Injury prevention should always be the paramount consideration when building armour. First off make sure that the armour fits! There is nothing worse, in the heat of a battle, than finding that your greaves are chewing up your ankles and your shield is trying to bend your wrist at an impossible angle. Secondly learn to move in your armour; no matter how little armour you wear some mobility and vision will be lost. If you don't get used to wearing your armour its sheer weight can cause muscle strain! The solution—wear your armour when practising to get use to it and warm up before you fight to reduce the chance of hurting yourself. Also keep your armour well maintained; if it's broken it won't protect you!

FIGHTING STYLES



Chapter 19 — Aftermath

While relaxing with a beer, after running around Edzell Castle in armour all day, Gytha and Richard wandered over with a really simple question; could they reprint my old guide to making armour? They were starting up a group and having problems getting them into armour. Much digging at home later I uncovered an ancient copy of the first edition of this tome (did I really hand write everything in those days?) and thought “Oops, I’ve learnt a bit since then!”, hence this rewrite! I’ve tried to keep to the original idea as much as possible—simple, practical armour that can be easily made at home—so the gothic gauntlets and breast plates didn’t find their way in! Maybe I’ll do a follow up...

Acknowledgements

Thanks go to Gytha North and Richard the Rampant without whom this book would never have seen the light of day less alone end up on a web site; Dr Michael Lacey (historian in exile); Dave Cowland (armour denter extra-ordinary); Heather Phillips (chief korrektor of Englizh); Mike Bradford (Danish correspondent); Denzil Brown (armour crash test dummy); Pete Nash (mandatory man in Black); Steve “Give that here, I can fix it!” Tanner; and every one else who gave a hand in this project with patterns, ideas or simply bringing sanity to what I’d written! Hope you find our efforts useful.

The Scribbler

For those of you interested in such things Paul Blackwell is a scientist/engineer with an interest in period armour, fighting styles, dance and cooking and whose other hobbies include caving, folk music, Karate, science fiction role playing and drinking good beer.

P.S. if you have enjoyed this book then mine’s a pint!



AFTERMATH



Chapter 20 — More Bits!

Books

A selection of things to read while relaxing after a hard day in the workshop.

History of Armour

Arms & Armour of the Medieval Knight. D Edge, J Paddock. Defoe: London, 1988.

Well illustrated and written book on armour. Highly recommended!

Arms and Armour, Pleasures & Treasures. Vesey Norman. Weidenfeld & Nicolson: London, 1964 & 1969.

Developments from mail until obsolescence in 17C. Lots of photographs; often found in second hand book shops.

European Armour Circa 1066 to 1700. C Blair. B T Batsford Ltd: London, last reprint 1972.

Excellent general study on armour. Also to be found in second hand book shops.

Leather and the Warrior. John Waterer. Museum of Leathercraft: 1981.

Description of leather and its use by the military from the ancient Greeks until World War II; includes useful section on Cuir Bouilli.

Osprey books—Men at Arms and Elite Series. Osprey Publishing: London.

Series of reasonably priced books on the history, organisation, appearance and equipment of troops through the ages. Good background information and superb illustrations.

Techniques

Butted Mail; A Mail Maker's Guide, 4th edition. P Blackwell & T Barker. 1997.

Instructions on making mail available on line at:

<http://homepage.ntlworld.com/trevor.barker/farisles/guilds/armour/mail.htm>

MORE BITS!

Medieval Craftsmen, Armourers. Matthias Pfaffenbichler. British Museum Press: 1992.

The history of Armourers, their work, guilds etc. Illustrations of armourers at work and photographs of many fine harnesses.

Make your own Gloves. Gwen Emlyn-Johnes.

Comprehensive book on gloves; useful for gauntlet liners.

Metalsmithing for the artist craftsman. Richard Thomas. Chilton Book Company: 1960.

When my poor attempts to describe metalworking techniques fail turn to this book; it's clear precise and well illustrated.

Techniques of Medieval Armour Reproduction, the 14th Century. Brian Price. Paladin Press: USA, 2000.

Quite possibly the best book of making armour printed to date!

The Armourer and His Craft. Charles Ffoulkes. Dover Books: (reprint) 1988.

Classic reference work.

The Best Of the Hammer; B Flax (ed.); Raymond's Quiet Press: Albuquerque, USA. <http://www.quietpress.com>

Best material from SCA journal on armouring.

Armour Itself

Arms and Armour in Britain. Alan Borg. HMSO publications: latest edition 1986.

Small booklet describing some of the pieces at the Royal Armouries

Armour from the Battle of Wisby 1361. B. Thordemann. Stockholm, 1939, 2 Vols.

Volume 1 contains much information on 14C armour, whilst volume 2 comprises 1/4 scale drawings of the coats of plates.

European Arms and Armour at Kelvingrove. J. Scott. Glasgow Museums and Art Galleries, 1980.

Small booklet describing this fine collection.

The Medieval Armour From Rhodes. W.J. Karcheski, T. Richardson. Royal Armouries & Higgins Museum, 2000.

15C & 16C armours discovered on Rhodes, many of which are now at Leeds.

The Medieval Soldier, 15C Campaign Life Recreated in Colour Photographs. Gerry Embleton, John Howe. Windrow & Green Ltd: London, 1994.

See how others have reproduced armour!

Wallace Collection Catalogues. J Mann. Trustees of the Wallace Collection: London.

Details of the collection at Manchester Place in London.

Museums

There is no better way to find out how armour works than to go and see the real thing! Lots of museums, castles and the like display the odd bit of armour—so drop into your local one immediately! Here is a random selection of places I've enjoyed visiting. If I've missed anything good out please invite me over!

Austria

Kunsthistorische Museum, Vienna.

Incredible collection. Has my all time favourite harness; that of Archduke Sigismund of Tyrol by Lorenz Helsehmied, um, WOW, go there!

The Museum of Archduke Ferdinand II at in Schloss Ambras, near Innsbruck.

Collection founded by Ferdinand II, ruler of Tyrol, housed in the lower castle which was purpose built for it in 1570s. Nice castle; glorious armours!

Landeszeughaus, Graz.

Only existing period town arsenal in it's original building. Go see what the common folk got issued! An experience not to be missed!

Britain

British Museum, London.

Sutton Hoo helm and various other pieces. Intriguing place to wander around; give 'em a donation when you leave.

Castle Museum, York.

The Coppergate helm—no its not in the Jorvik Centre where you'd expect!

Kelvingrove Gallery, Glasgow.

Collection with some of my favourite pieces of 15C armour. Well worth a visit!

Royal Armouries, Leeds.

Huge, new, ugly, building in the middle of nowhere (even if you live in Leeds) housing excellent collection. Needs an entire day to get around and see the various demonstrations etc. Not cheap but worth it!

Tower of London.

The Royal Armouries have moved most of their stuff to Leeds, but the tower still has Henry VIII's armours and a few other pieces. Expensive to get in!

Victoria & Albert Museum, London.

Some armour and lots of casts from effigies, statues etc. Which saves on travel to little out of the way churches. Now free again so pop in quick before the entrycharge returns (and have a look at the excelent new British Gallery while you are there!)

Wallace Collection, Manchester Place, London (just off Oxford Street).

Excellent collection of Arms and Armour, helpful staff and they run study days. What more could you ask? OK entrance is free.

MORE BITS!

France

Musée de L'Armée (in the Hôtel des Invalides) Paris.

Military history from the Middle Ages to World War II. Fine selection of armour and you even get a glimpse of their storage area, to see all the other bits they don't have on display!

Germany

Munchner Stadtmuseum, Munchen.

Lots of splendid 15C armour, oh—and some later stuff. Biased, me?

Italy

Il Museo Stibbert, Florence.

Glorious old collection, still displayed in its original form; the paper mache horses are great and watch out for the bits added by the butler! If you ask very nicely the might let you look at their textiles as well.

Museo delle Armi, Brescia.

Collection ranging from plain 14C helms to highly decorated 17C harnesses.

Sweden

National Historical Museum, Stockholm.

The majority of the Wisby coats of plates.

Livrustkammaren, Stockholm.

Fascinating display of tourney equipment.

Gotland Museum, Wisby.

Various pieces from the battle of 1361, however most of the finds are in Stockholm.

Suppliers

Tricky one this; if I don't give any people moan, if I do they complain they are all in the south of England! Sorry, but that's where I live! Good places to look for bits are second hand tool shops, clearance yards, steam rallies, model engineering exhibitions and agricultural auctions.

Re-enactors markets

These are held various times of the year in places such as Oxford and Cressing Temple. Big re-enactment events such as Tewkesbury also tend to have markets (check English Heritage etc. event listings). Good places to get cloth, leather, period looking buckles etc.

Companies

Call to Arms, 1 LNG Lane, North Lopham, Norfolk IP22 2HR.

The re-enactors directory, lists groups and specialist suppliers; go buy a copy!

<http://www.calltoarms.com>

MORE BITS!

J T Batchelors, 9-10 Culford Mews, London N1 4DZ.

Leather suppliers who are used to dealing with re-enactors. Sell Leather in all shapes and sizes, buckles, rivets, punches, dyes etc.

Rivet Supply Co, Power Road, Chiswick, London W4.

Rivets, rivets and more rivets, and good prices.

J. Hurst & Sons, Bank Top, (up Springhill Lane) St Maryborne, Nr. Andover, Hants, SP11 6BG.

Tool/recovery yard with hammers, anvils, cutters or maybe nothing—depending when you visit and if you can find where they have hidden it!

Web Sites

There are huge amounts of information on the web; the trick is finding the useful bits! Here are a few places to start from.

<http://www.arador.com>

Armour library. Many useful articles

<http://www.armorarchive.org>

Essays etc.

<http://www.baba.org.uk>

British Artist Blacksmith Association; tools, courses, books etc.

<http://www.battlegames.co.uk>

Osprey book reviews.

<http://www.chronique.com>

Knighthood, Chivalry & Tournaments resource library—Chalcis armour etc.

<http://www.forth-armoury.com>

Forth Armoury; excellent information of making riveted mail.

<http://www.drachenwald.sca.org>

Society for Creative Anachronisms, European web site. SCA armour & combat regulations; links to other combat, armour and medieval sites including The Isles home page (SCA UK & Ireland) with articles on Béhours, period fighting techniques etc.

<http://www.angelcynn.org.uk>

Information on Pioneer Helmet including photos of reproduction.

<http://www.webring.com/webring?ring=armour&list>

“The Armour Ring” a collection of web sites containing useful information on armourers and armouring.

<http://www.livinghistory.co.uk>

Various articles on historical subjects and links to UK re-enactment sights.

http://www.lrp-index.org.uk/How_to_guides/Armour/

Live role playing site with links to several interesting armour pages.

Colophon

The text of the document was produced in Microsoft Word. It was then edited by Gytha North and Toby Atkin. All of the illustrations in the book were original pen and ink works produced by Paul Blackwell. Richard the Rampant scanned each illustration and converted it to line-art using Adobe Streamline. The illustrations were simplified and cleaned by Andrew Patterson using Adobe Illustrator 9 to reduce the file size while maintaining the original image quality.

The book was typeset by Andrew Patterson in Adobe InDesign 1.5. The text and heading fonts are ITC New Baskerville. Adobe Acrobat 5.0 was used to optimise and split the PDF file ready for upload to the web site.



Fortunately the blow rebounded off his
Armoured Cod piece